

ΚΛΙΜΑΤΙΣΤΙΚΑ ΣΥΣΤΗΜΑΤΑ  
AIR CONDITIONING SYSTEMS

Models: AR1MVI32-09WIFIR/AR1MVO32-09  
AR1MVI32-12WIFIR/AR1MVO32-12  
AR1MVI32-18WIFIR/AR1MVO32-18  
AR1MVI32-24WIFIR/AR1MVO32-24

 **inventor**<sup>®</sup>  
Your-conditions

Wall Mounted Unit  
**User's Manual**

Επιτοίχια Μονάδα  
**Εγχειρίδιο Χρήστη**

Σας ευχαριστούμε που επιλέξατε τη μονάδα κλιματισμού της INVENTOR. Για τη σωστή χρήση της μονάδας, παρακαλούμε διαβάστε προσεκτικά το παρόν εγχειρίδιο και φυλάξτε το για αναφορά στο μέλλον.

Thank you for choosing INVENTOR air conditioning system. For correct use of this unit, please read this manual carefully and keep it for future reference.



English/Ελληνικά/ Română

 **inventor**<sup>®</sup>  
Your-conditions

READ BEFORE OPERATION

---

When using this air conditioner in the European countries, the following informations must be followed:

- This appliance can be used by children aged from 8 years and above and persons with reduced physical, sensory or mental capabilities, or lack of experience and knowledge if they have been given supervision or instruction concerning use of the appliance in a safe way and understand the hazards involved. Children shall not play with the appliance. Cleaning and user maintenance shall not be made by children without supervision.

**DISPOSAL:** Do not dispose of this product as unsorted municipal waste. Collection of such waste separately for special treatment is necessary.

It is prohibited to dispose of this appliance in domestic household waste. For disposal, there are several possibilities:

- A) The municipality has established collection systems, where electronic waste can be disposed of at least free of charge to the user.
- B) When buying a new product, the retailer will take back the old product at least free of charge.
- C) The manufacturer will take back the old appliance for disposal at least free of charge to the user.
- D) As old products contain valuable resources, they can be sold to scrap metal dealers.

Wild disposal of waste in forests and landscapes endangers your health when hazardous substances leak into the ground-water and find their way into the food chain.

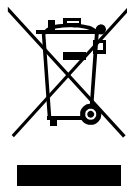

CONTENTS

**SAFETY PRECAUTIONS**

Warning .....3  
Caution .....4

**NAMES OF PARTS**

Indoor unit .....5  
outdoor unit .....5  
Display window .....5

**OPERATING INSTRUCTIONS**

Operating temperature.....6  
Manual operation .....6  
Airflow directional control .....7  
How the air conditioner works .....8  
Special functions .....9

**CARE AND MAINTENANCE**

Before maintenance.....11  
Cleaning the unit.....11  
Cleaning the air filter and air freshening filter .....11  
Preparation for extended non-operation.....12  
Pre-season inspection.....12



**TROUBLESHOOTING TIPS**

Troubleshooting tips.....13  
Troubleshooting guide .....14





Caution: Risk of fire/  
flammable materials



To prevent injury to the user or other people and property damage, the following instructions must be followed. Incorrect operation due to ignoring of instructions may cause harm or damage. The seriousness is classified by the following indications.

 <b>WARNING</b>	This symbol indicates the possibility of death or serious injury.
 <b>CAUTION</b>	This symbol indicates the possibility of injury or damage to property.



■ Meanings of symbols used in this manual are as shown below.

	<b>Strictly prohibited.</b>
	<b>Be sure to follow the instructions.</b>

 **WARNING**

	
<ul style="list-style-type: none"> <li>Do not extend the cable and never use multiple plugs. A poor electrical connection, poor insulation or voltage which is higher than permitted can cause fire.</li> <li>Do not expose your body directly to the cool air for prolonged period.</li> <li>Never poke fingers, sticks or other objects in the air inlet and outlet vents.</li> <li>Never attempt to repair, relocate, modify the air conditioner yourself. Always contact your service provider if required.</li> <li>Never pull the plug out by pulling on the cable. Hold the plug firmly and pull it out of the plug socket, otherwise there is a risk of damaging the cable.</li> <li>Do not operate your air conditioner in a wet room such as a bathroom or laundry room.</li> </ul>	<ul style="list-style-type: none"> <li>Remove all dirt from the power plug and plug it firmly. Soiled plugs can cause fire or an electric shock.</li> <li>In the event of any abnormalities such as smell of burning, immediately switch off the device and pull the plug. Contact your service provider.</li> <li>Always switch off the device and pull the plug before you start to clean it.</li> <li>Use specified power cord.</li> <li>Contact the authorized installer for installation of this unit.</li> <li>Contact an authorized service technician for repair or maintenance of this unit.</li> <li>This appliance is not intended for use by persons (including children) with reduced physical, sensory or mental capabilities, or lack of experience and knowledge, unless they have been given supervision or instruction concerning use of the appliance by a person responsible for their safety.</li> <li>Children should be supervised to ensure that they do not play with the air conditioner.</li> </ul>

 **CAUTION**

	
<ul style="list-style-type: none"> <li>Never actuate any switches with a wet hand. It may cause an electric shock. Never use the device for any other purpose than the intended use. Never place food, precision instruments, plants, animals, paint, etc. on the unit.</li> <li>Do not expose plants or animals directly to the air flow.</li> <li>Never clean the air conditioner with water.</li> <li>Never use combustible cleaning agents as these could cause a fire or deformation.</li> <li>Never place any burning objects close to the device if they could be directly affected by the emitted air.</li> <li>Never step onto the outdoor unit and never place anything on it.</li> <li>Never install the air conditioner in places where combustible gas can be emitted. Emmitted gas may collect and cause an explosion.</li> <li>Never allow the air conditioner to run for too long with the doors or windows open, or if the humidity is very high.</li> </ul>	<ul style="list-style-type: none"> <li>If the air conditioner is to be used in conjunction with other heaters, the air should be refreshed periodically, otherwise there is a risk of lack of oxygen.</li> <li>Always pull out the power plug if the unit is not going to be used for any lengthy period of time. Collections of dust can cause fire.</li> <li>Always switch off the air conditioner and pull out the power plug during a storm, otherwise, electrical parts may get damaged.</li> <li>Check that the drainage line is correctly connected. If not, water will escape.</li> <li>Check that the condensation water can run off unhindered. It may cause water damage if the condensation water cannot run off properly.</li> <li>The air conditoner must be earthed in accordance with the local codes.</li> <li>For electrical safety purposes we recommend that you install an earth-leakage circuit-breaker.</li> <li>If the power cord is damaged, it must be replaced by the manufacturer, its service agent or similary qualified persons in order to avoid a hazard.</li> </ul>

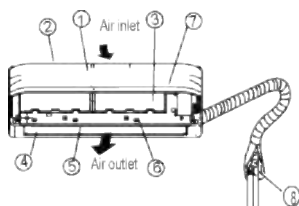

**Names of parts**

**Indoor unit**

1. Front panel
2. Air inlet
3. Air filter
4. Air outlet
5. Horizontal air flow grille
6. Vertical air flow louver(inside)
7. Display window

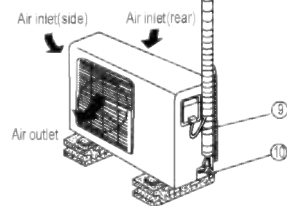

**Outdoor unit**

8. Connecting pipe
9. Connecting cable
10. Stop valve

**NOTE:**

All the pictures in this manual are for explanation purposes only. The actual shape of the indoor unit you purchased may be slight different on front panel and display window. The actual shape shall prevail.

**Display window**

**EE Digital display:**

- Displays the temperature settings when the air conditioner is operational.
- Displays the room temperature in FAN mode.
- Displays the self-diagnostic codes.
- Displays 'ON' for three seconds when Timer ON, Fresh, Swing, Turbo or Silence feature is activated.
- Displays 'OF' for three seconds when Timer OFF is set.
- Displays 'DF' for three seconds when Fresh, Swing, Turbo or Silence feature is cancelled.
- Displays 'dF' under defrosting operation.
- Displays 'eF' when anti-cold air feature is activated under heating mode.
- Displays 'SC' during self clean operation(if applicable).
- Displays 'FP' under 8°C heating operation(if applicable).

**°C (Optional)**

- According to the operation mode, the "°C" indicator displays different colour:
- Under Cool or Dry mode, it displays as cool colour.
  - Under Heat mode, it displays as warm colour.

**Display window**



ECO

**Energy saving display(optional):**

Displays when the energy saving feature is activated.(Not available when the unit does not have energy saving mode.)



**WIFI control display(optional):**

Displays when the WIFI control feature is activated.(Not available when the unit does not have this function.)

**NOTE:**

A guide on using the infrared remote is included in this literature package.

**Operating temperature**

Mode	Cooling operation	Heating operation	Drying operation
Room temperature	17°C~32°C (62°F~90°F)	0°C~30°C (32°F~86°F)	10°C~32°C (50°F~90°F)
Outdoor temperature	0°C~50°C (32°F~122°F)	-15°C~30°C ( 5 °F~ 86 °F)	0°C~50°C (32°F~122°F)
	(-15°C~ 50°C/ 5°F~122°F: For the models with low temperature cooling system)		

**NOTE:**

1. Optimum performance will be achieved within these operating temperatures.If air conditioner is used outside of the above conditions, certain safety protection features might come into operation and cause the unit to function abnormally.
2. If the air conditioner runs for a long time in cooling mode and the humidity is high(over 80%) , condensed water may drip out of the unit. Please sets the vertical air flow louver to its maximum angle (vertically to the floor), and set HIGH fan mode.

**Suggestion:** For the unit adopts an Electric Heater, when the outside ambient temperature is below 0°C(32°F), we strongly recommend you to keep the machine plugged in order to guarantee it running smoothly.

**Manual operation**

Units are equipped with a switch to run emergency operation mode. It can be accessed by opening the front panel. This switch is used for manual operation in case the remote controller fails to work or maintenance necessary.

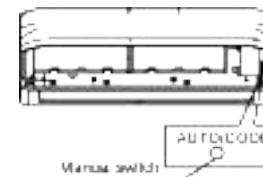

**NOTE:** The unit must be turned off before operating the manual control button. If the unit is operational, continue pressing the manual control button until the unit is off.

- ① Open and lift the front panel up to an angle until it remains fixed with a clicking sound.
- ② One press of the manual control switch will lead to the forced AUTO operation. If press the switch twice within five seconds, the unit will operate under forced COOL operation.
- ③ Close the panel firmly to its original position.

**CAUTION:**

- + This switch is used for testing purposes only. Please do not use it unless necessary.
- + To restore the remote controller operation, use the remote controller directly.

**Airflow directional control**

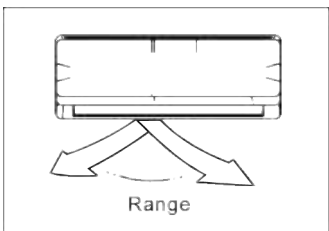
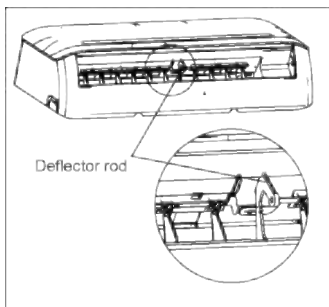
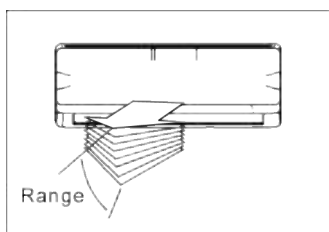

- Adjust the air flow direction properly, otherwise it might cause discomfort or cause uneven room temperatures.
- Adjust the horizontal louver using the remote controller.
- Adjust the vertical louver manually.

**Adjusting vertical air flow(Up-Down)**

Perform this function while the unit is in operation. Use the remote controller to adjust the vertical air flow direction. The horizontal louver can move slightly for each press, or continuously swing up and down automatically. Please refer to the ‘REMOTE CONTROLLER OPERATION MANUAL’ for details.

**Adjusting horizontal air flow (left - right)**

- Move the deflector rod manually to adjust the air flow in the direction you prefer.
- IMPORTANT:** Do not put your fingers into the panel of the blower and suction side. The high-speed fan inside may cause injury.

**⚠ CAUTION**

- Do not operate the air conditioner for long periods with the air flow direction set downward in cooling or dehumidifying mode. Otherwise, condensation may occur on the surface of the horizontal louver causing moisture to drop on to the floor or on furnishings.
- After a quick restart, the horizontal louver may remain static for approximately 10 seconds.
- Open angle of the horizontal louver should not be set too small, as COOLING or HEATING performance may be reduced due to too restricted air flow area.
- Do not move the horizontal louver manually, otherwise the horizontal louver will be out of sync. But if this happens, please cease operating, unplug power for a few seconds, then restart the air conditioner.

**How the air conditioner works**

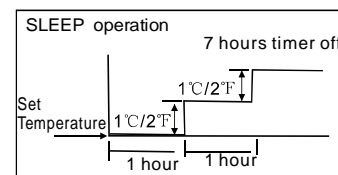

Cooling

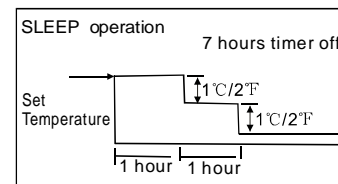

Heating

**Basic operation modes:** AUTO/COOL/DRY/HEAT\*  
 (\* ) Model dependent

**AUTO operation**

- When you set the air conditioner in AUTO mode, it will automatically select cooling, heating (cooling/heating models only), or fan only operation depending on set temperature and the room temperature.
- The air conditioner will control room temperature automatically to the temperature point you set.
- If you feel uncomfortable in the AUTO mode, you can set your desired temperature.

**SLEEP operation**

When selected, the set temperature will increase (cooling) or decrease (heating) by 1°C/2°F per hour for the first 2 hours. Thereafter it keeps this new temperature for 5 hours before switching off. This operation saves energy and improves night time comfort by synchronising with the body’s metabolism.

**DRYING operation**

- The temperature is regulated while dehumidifying by repeating turning on and off of the cooling operation or fan only. The fan speed is LOW.

**HEATING operation**

This air conditioner operates on the heat-pump principle, absorbing heat from air outdoors and transferring that heat to the indoor unit. As a result, the operating performance is reduced as outdoor air temperature drops. If you feel that the heating performance is insufficient, we recommend you to use this air conditioner in conjunction with other kinds of heating appliance.

**Optimal operation**

- To achieve optimal performance, please note the following:
- Adjust the air flow direction correctly so that it is not towards people.
  - Adjust the temperature to achieve moderate comfort levels. Excessively low or high temperature waste energy.
  - Improve performance by keeping windows and doors closed.
  - Limit energy usage (run time) by using the TIMER function.
  - Do not put any object near air inlet or air outlet, as the efficiency of the air conditioner may be reduced and may cause the air conditioner to stop running.
  - Inspect the air filters periodically, and clean them when needed.

**Special functions****Refrigerant Leakage Detection(Optional)**

When refrigerant leakage is detected, the indoor unit will display 'EC' code or flash LEDs(model dependent).

**Louver Angle Memory Function(optional):**

Within the scope of safety angle, the horizontal louver angle is memorised and will return to the position last selected by user. If it exceeds, it will memorize the boundry of safety angle. This will not happen when Turbo or manual control buttons are pressed or after a power interruption. So we strongly suggest that the open angle of the horizontal louver should not be set too small, in case the condensed water forms and drips from the horizontal louver.

**SELF CLEAN function(Optional)**

- Airborne bacteria use the moisture on the indoor heat exchanger to grow. Regular drying of the exchanger prevents this growth. By simply pressing the SELF CLEAN button, the system will automatically manage the process. This cleaning action may be done as frequently as desired.
- For cooling models, only the indoor fan is active in low speed for 30 minutes and the unit turns off automatically.
- For cooling & heating models, the unit will operate as in the following sequence : FAN mode at Low fan speed--Heating operation with LOW fan speed ---FAN operation--Stop Operation---Turn off.

**Note:**

- This function is only activated in COOLING or DRY mode.
- Before activation the air conditioner, it is recommended to run the air conditioner under cooling operation for about 30 minutes.
- Pressing the SELF CLEAN or ON/OFF button again during the cleaning cycle will cancel the operation and turn the unit off.

**CLEAN AIR function(Optional)**

Improving the quality of indoor air is one of the purposes of an air conditioner. This air conditioner is equipped with ionizer or Plasma Dust Collector(model dependent). With the anions generated by Ionizer, the air circulation of the air conditioner fills the room with refreshing, natural and healthy air. The Plasma Dust Collector generates a high voltage ionization zone, through which the air is converted to plasma. Inside the air most of the dust, smoke, and pollen particles are captured by the electrostatic filter.

**Anti-mildew function(Optional)**

When turns off the unit on COOL, DRY, AUTO (Cool) mode, the air conditioner will continue operating for about 10 minutes (depending on models) with soft wind. This will help to dry up the condensed water inside the evaporator, and prevent the mildew growth. Under Anti-mildew operation, do not restart the air conditioner until the unit is completely off.

**Anto-restart function(Optional)**

In event of power interruption such as a blackout, the air conditioner stops once. But it restarts automatically and performs previous operation when the power supply is resumed.

**WIFI Control Function(optional)**

For the unit with WIFI control function, connect the WIFI module and communication module with display board, so the unit can be controlled either by remote controller or by mobile telephone.

**Air Filter Reminding Function(optional)****Cleaning filter reminding function:**

After 240 hours of operation, the indoor display window will display and flash 'CL', this feature is a reminder to clean the Air Filter for more efficient operation. After 15 seconds, the system will revert back to the previous display again. When the 'CL' indicator appears and flashes, please press the LED button on remote controller for 4 times or press the Manual control button for 3 or more times to clear the registered hours, otherwise the 'CL' indicator will display and flash again for another 15 seconds at the next time of tarning the unit.

**Replacing filter reminding function:**

After 2880 hours of operation, the indoor display window will display and flash 'nF', this feature is a reminder to replace the Air Filter for more efficient operation. After 15 seconds, the system will revert back to the previous display again. When the 'nF' indicator appears and flashes, please press the LED button on remote controller for 4 times or press the Manual control button for 3 or more times to clear the registered hours, otherwise the 'nF' indicator will display and flash again for another 15 seconds at the next time of starting the unit.

**Mute operation(optional)**

Press the LED button on the remote controller can turn off the indoor screen display, and also turn off the Air conditioner buzzer, which create a comfortable and quiet environment.

**Care and Maintenance**

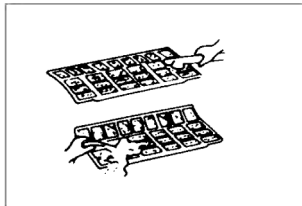
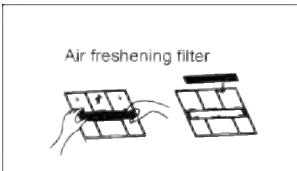
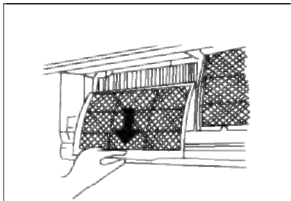
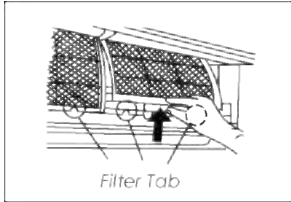
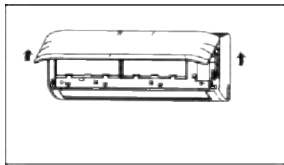

**WARNING:** Servicing shall only be performed as recommended by the equipment manufacturer. Maintenance and repair requiring the assistance of other skilled personnel shall be carried out under the supervision of the person competent in the use of flammable refrigerants. For more details, please refer to the “Information on servicing” on “INSTALLATION MANUAL”.

**Before maintenance**

- Turn the system off before cleaning. To clean, wipe with a soft, dry cloth. Do not use bleach or abrasives.

**NOTE: Power supply must be disconnected before attempting to clean or service!**

**CAUTIONS**

- Do not use a chemically treated cloth or duster to clean the unit.
- Do not use benzene, thinner, polishing powder, or similar solvents for cleaning. These may cause the plastic surface to crack or deform.
- Never use water hotter than 40°C/104°F to clean the front panel, it could cause deformation or discoloration.

**Cleaning the unit**

wipe the unit with a soft dry cloth only. If the unit is very dirty, wipe it with a cloth soaked in warm water.

**Cleaning the air filter and air freshening filter**

A clogged air filter reduces the cooling efficiency of this unit. Please clean the filter once every 2 weeks.

1. Open the front panel by carefully lifting both ends at the same time. At a certain angle, a clicking sound is heard and it becomes self-supporting. For some models, please use the suspension bars to prop up the panel.
2. Use the tab provided to move the filter first up a little, then slightly towards you. Now extract the filter by gently drawing downwards.
3. Unclip the small air freshening filter from the large air filter. Clean it with vacuum, and replace it occasionally.
4. Clean the large air filter with soapy water. Rinse with fresh water. Shake off excess water and dry it up in cool place, replace it occasionally.

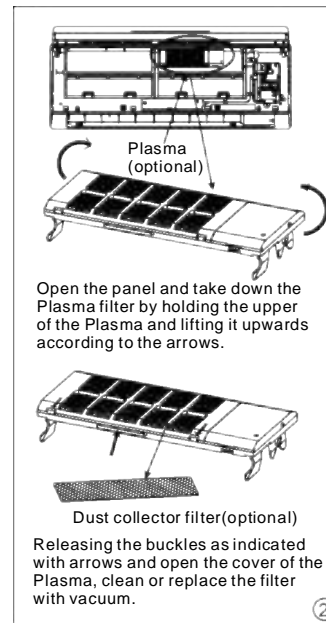

- △ For the models adopts Plasma, do not touch the plasma within 10 minutes after you open the panel. Clean the Plasma according to the description in the figure left.

5. Refit the small air freshening filter onto the large air filter.
6. Re-insert into unit in the reverse order described in point 2 above.
7. Close the front panel. Make sure the buckles are fully fit and the panel is completely closed.

**Preparation for extended non-operation**

If you plan to idle the unit for a long time, perform the following:

- (1) Clean the indoor unit and filters.
- (2) Operate the fan for about half a day to dry the inside of the unit.
- (3) Stop the air conditioner and disconnect power.
- (4) Remove the batteries from the remote controller. The outdoor unit requires periodic maintenance and cleaning. Do not attempt to do this yourself. Contact your dealer or service provider.

**Pre-season inspection**

- Damaged or disconnected wires.
- Clean the indoor unit and filters.
- Check water or oil leaks.
- Check if the air outlet or inlet is blocked after the air conditioner has not been used for a long time.

**Caution**

- Do not touch the metal parts of the unit when removing the filter. Injuries can occur when handling sharp metal edges.
- Do not use water to clean inside the air conditioner. Exposure to water can destroy the insulation, leading to possible electric shock.
- When cleaning the unit, first make sure that the power and circuit breaker are turned off.
- Do not wash air filter with hot water at more than 40°C/104°F. Shake off moisture completely and dry it in the shade. Do not expose it directly to the sun, it may shrink.

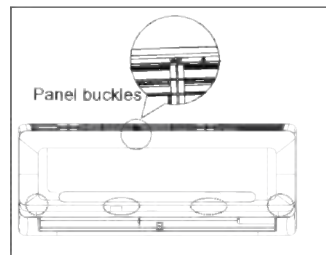
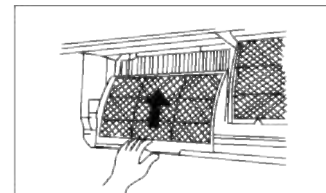

**Troubleshooting tips**

The following events may occur during normal operation, and may not indicate malfunction.

Symptom	Cause
<b>Operation is delayed after restart</b>	To prevent blowout of the fuse, the compressor will not operate while the protection circuit is working for about 3 minutes after sudden OFF--ON operation of the power supply.
<b>Fan speed changes-off, very slow and then normal</b>	Automatically happens in heating mode : --prevents cold air blowing onto occupants when the heating operation is start, --perform automatic defrosting operation, --perform low temperature heating operation
<b>Heating operation stops suddenly and defrost-light blinks</b>	In HEAT mode, the indoor unit temporarily stops for maximum of 10 minutes to perform the automatic defrosting operation.
<b>Mist coming out of the indoor unit</b>	In COOL mode, a mist generated by condensation formed with sudden cooling process may be emitted. Mist may generate due to moisture generated from defrosting process when the air conditioner restarts in HEAT mode operation after defrosting.
<b>Low volume sounds are emitted by the air conditioner</b>	Hissing sound-- during operation or immediately after stopping the air conditioner, refrigerant flowing sound may be heard. Squeaking sound-- normal expansion and contraction of plastic and metal parts caused by temperature change during the operation. Rushing air-- when louver resets its position.
<b>Dust discharges from the unit</b>	May occur when air conditioner is used for the first time or has not been used for a long time.
<b>Emits a peculiar odour</b>	Various smells generated from interior textile, furniture, or cigarette smoke absorbed into the air conditioner may be emitted. If not the case call your suitable contractor.
<b>Changes to fan only while cooling or heating mode</b>	Room temperature reaches the temperature setting of the remote control. If not the case call your suitable contractor.
<b>Operation is erratic, unpredictable or unresponsive</b>	Interference from cell phone towers and remote boosters may cause the unit to malfunction Disconnect the power and then re-connect. Press the ON/OFF button on the remote controller to restart operation.

**NOTE:** If the problem is not resolved, please contact a local dealer or the nearest customer service center. Be sure to inform them of the detailed malfunctions and unit model number.

**Troubleshooting guide**

Before you call for or request servicing, troubleshoot a problem by performing following checks:

Symptom	Diagnostic
<b>Unit will not operate</b>	-- Is there a power failure?
	-- Has a switch been turned off, a circuit breaker tripped or a fuse blown?
	-- Is the timer operating?
	-- Are the batteries used in the remote controller exhausted?
	-- Are the batteries used in the remote controller loaded properly?
<b>Poor cooling or heating performance</b>	-- Are the air filters dirty?
	-- Is air flow unrestricted in & out of indoor & outdoor units?
	-- Are the temperature and mode settings correct?
	-- Are the windows or doors left opened?
	-- Is fan speed on high and louvers allowing maximum flow?
	-- Is direct or strong sunlight shining into the room in cooling operation?
	-- Are there other heating apparatus or computers operating, or too many people in the room in cooling operation?
-- Is the "SILENCE" function is activated? Under "SILENCE" operation, noise reduction is prioritized and the air-conditioning performance may become lower.	
<b>Indicator lamps continue flashing</b>	-- The unit may stop operation or continue to run in a safety condition (depending on models). Waiting for about 10 minutes, the fault may be recovered automatically, if not, disconnect the power and then connect it in again. If the problem still exists, disconnect the power and contact the nearest customer service center.
<b>Error code appears in the indoor unit, such as: E0,E1,E2.... P1,P2,P3....or F1, F2, F3....</b>	

If the problem persists even if you perform these checks or diagnostics, immediately stop operation and contact the authorized service center. Be sure to inform them of the detailed malfunctions and unit model number.

**⚠ CAUTION**

**In the case of ANY of the following, turn off the unit immediately!**

- Power cord is damaged or abnormally warm.
- Burning odours are smelled.
- Loud or abnormal sounds are heard.
- A power fuse blows or a circuit breaker trips frequently.
- Water or other objects fall into or out of the unit.

**⚠ DO NOT ATTEMPT TO CORRECT THESE ITEMS YOURSELF!  
CONTACT A AUTHORIZED SERVICE PROVIDER!**



NOTES:

Activate your warranty.....

in **5**  
simple  
**steps!**



Scan here for the  
warranty form

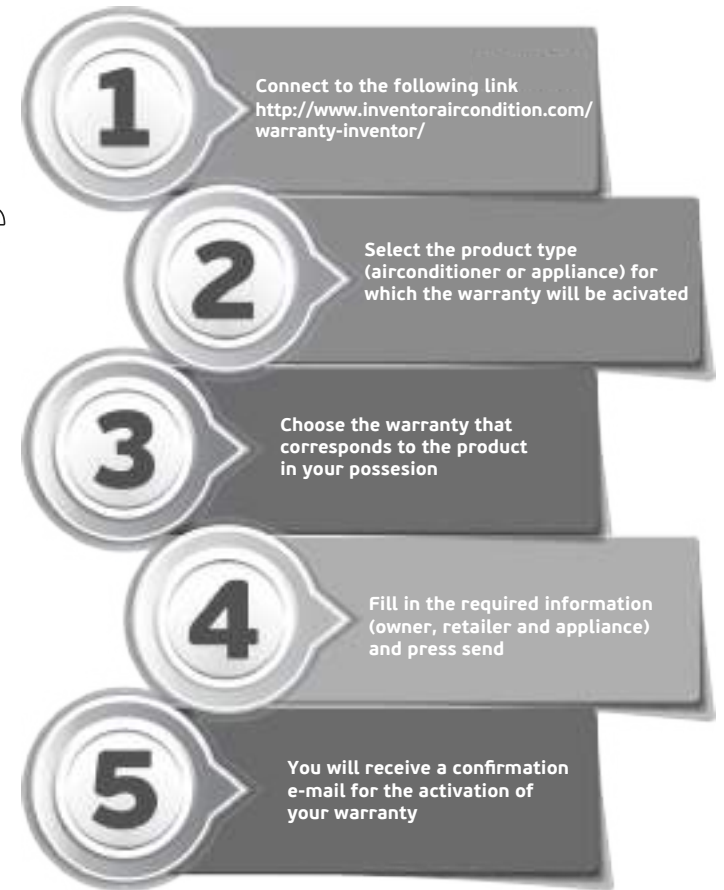

For the electronic  
warranty submission  
please type the following link

**[http://www.  
inventoraircondition.com/  
warranty-inventor/](http://www.inventoraircondition.com/warranty-inventor/)**

## Διαβάστε πριν από τη λειτουργία

Όταν χρησιμοποιείτε το κλιματιστικό στην Ευρωπαϊκή Ένωση, παρακαλούμε διαβάστε τα παρακάτω:

- Αυτή η μονάδα μπορεί να χρησιμοποιηθεί από άτομα πάνω από 8 ετών και από άτομα με ειδικές ανάγκες ή έλλειψη εμπειρίας και γνώσης αρκεί να επιβλέπονται από άτομα υπεύθυνα για την ασφάλειά τους. Βεβαιωθείτε πως τα παιδιά δεν παίζουν με τη μονάδα.

**ΑΠΟΡΡΙΨΗ:** Μην απορρίπτετε αυτό το προϊόν μαζί με τα αστικά λύματα. Θα πρέπει να περισυλλέγονται για ειδική επεξεργασία.

Απαγορεύεται η απόρριψη αυτού του προϊόντος με τα αστικά λύματα. Για την απόρριψη τους υπάρχουν πολλές λύσεις:

- A) Έχουν ιδρυθεί ειδικά κέντρα απόρριψη ηλεκτρικών αποβλήτων.
- B) Κατά την αγορά ενός καινούριου προϊόντος ο προμηθευτής σας μπορεί να πάρει πίσω το παλιό χωρίς χρέωση.
- Γ) Ο κατασκευαστής μπορεί να πάρει την παλιά συσκευή χωρίς χρέωση
- Δ) Επειδή αυτά τα προϊόντα περιέχουν μεταλλικά υλικά, μπορείτε να τα πουλήσετε σε εμπόρους που αγοράζουν τέτοια υλικά.

Η απόρριψη τέτοιων προϊόντων σε δάση και πεδιάδες βάζει σε κίνδυνο την υγεία σας, καθώς τα επιβλαβή συστατικά που περιέχουν μπορεί να περάσουν στον υδριφόρο ορίζοντα και από εκεί στην τροφική αλυσίδα.



1

## ΠΕΡΙΕΧΟΜΕΝΑ

<b>ΟΔΗΓΙΕΣ ΑΣΦΑΛΕΙΑΣ</b>	
Προειδοποίηση .....	3
Προσοχή .....	4
<b>ΠΕΡΙΓΡΑΦΗ ΚΑΘΕ ΕΞΑΡΤΗΜΑΤΟΣ</b>	
Εσωτερική μονάδα .....	5
Εξωτερική μονάδα .....	5
Ενδεικτικές λυχνίες .....	5
<b>ΟΔΗΓΙΕΣ ΛΕΙΤΟΥΡΓΙΑΣ</b>	
Θερμοκρασία λειτουργίας .....	6
Χειροκίνητη λειτουργία .....	6
Ρύθμιση της κατεύθυνσης του αέρα .....	7
Πώς λειτουργεί το κλιματιστικό .....	8
Ειδικές λειτουργίες .....	9
<b>ΦΡΟΝΤΙΔΑ ΚΑΙ ΣΥΝΤΗΡΗΣΗ</b>	
Πριν τη συντήρηση .....	11
Καθαρισμός της μονάδας .....	11
Καθαρισμός των φίλτρων .....	11
Προετοιμασία για το τέλος της περιόδου χρήσης .....	12
Έλεγχοι πριν την έναρξη περιόδου χρήσης .....	12
<b>ΑΝΤΙΜΕΤΩΠΙΣΗ ΠΡΟΒΛΗΜΑΤΩΝ</b>	
Συμβουλές σε περίπτωση Σφάλματος .....	12
Οδηγός αντιμετώπισης προβλημάτων .....	14





**ΠΡΟΣΟΧΗ:**



Κίνδυνος πυρκαγιάς / Εύφλεκτα υλικά

2

Για την αποφυγή τραυματισμού του χρήστη ή οποιουδήποτε άλλου και καταστροφή περιουσίας, πρέπει να ακολουθηθούν οι παρακάτω οδηγίες ασφαλείας. Εσφαλμένη λειτουργία εξαιτίας αγνόησης των οδηγιών μπορεί να προκαλέσει τραυματισμό.

 <b>ΠΡΟΒΑΔΟΠΟΙΗΣΗ</b>	Αυτό το σύμβολο υποδεικνύει πιθανότητα θανάτου ή σοβαρού τραυματισμού.
 <b>ΠΡΟΣΟΧΗ</b>	Αυτό το σύμβολο υποδεικνύει την πιθανότητα τραυματισμού ή καταστροφή περιουσίας

■ Η σημασία των συμβόλων που εμφανίζονται σε αυτό το εγχειρίδιο φαίνονται παρακάτω

	<b>Απαγορεύεται</b>
	<b>Βεβαιωθείτε πως ακολουθείτε αυτές τις οδηγίες</b>

 **ΠΡΟΒΑΔΟΠΟΙΗΣΗ**



- Μην επεκτείνετε το καλώδιο και μην χρησιμοποιείτε πολύπριζα. Ελλιπής ηλεκτρολογική σύνδεση, εγκατάσταση ή αν η τάση είναι μεγαλύτερη από την επιτρεπόμενη μπορεί να προκαλέσει πυρκαγιά.
- Μην εκτείθετε το σώμα σας στον κρύο αέρα για πολλή ώρα.
- Μην εισάγετε τα δαχτυλά σας ή άλλα αντικείμενα στις εισόδους και εξόδους του αέρα.
- Μην επιχειρήσετε ποτέ να επισκευάσετε, μετακινήσετε ή να κάνετε κάποια μετατροπή στο κλιματιστικό σας. Επικοινωνήστε με τον προμηθευτή σας.
- Μην τραβάτε το καλώδιο για να το βγάλετε από την πρίζα. Κρατήστε σταθερά το καλώδιο και αφαιρέστε το φιν από την πρίζα.
- Μην λειτουργείτε το κλιματιστικό σας σε υγρά μέρη όπως μπάνια.
- Εάν το κλιματιστικό χρησιμοποιηθεί μαζί με άλλες θερμαντικές συσκευές θα πρέπει να ανανεώνεται συχνά ο αέρας αλλιώς υπάρχει κίνδυνος έλλειψης οξυγόνου.
- Να αποσυνδέετε πάντα το φιν από την πρίζα αν δεν χρησιμοποιήσετε τη μονάδα για αρκετό χρονικό διάστημα. Η συλλογή σκόνης μπορεί να προκαλέσει πυρκαγιά.
- Κατά τη διάρκεια καταιγίδας να απενεργοποιείτε τη μονάδα και να αποσυνδέετε το φιν από την πρίζα. Μπορεί να προκληθεί φθορά στα ηλεκτρικά μέρη.
- Ελέγξτε ότι ο αγωγός αποστράγγισης είναι συνδεδεμένος σωστά. Αν όχι, μπορεί να προκληθεί διαρροή νερού.
- Ελέγξτε ότι γίνεται ελεύθερη απορροή συμπυκνωμάτων.
- Η μονάδα θα πρέπει να είναι γειωμένη σύμφωνα με τους εθνικούς κανονισμούς.
- Για λόγους ασφαλείας συνιστούμε να τοποθετήσετε ένα ρελέ διαφυγής.
- Εάν το καλώδιο τροφοδοσίας είναι φθαρμένο, πρέπει να αντικατασταθεί από τον κατασκευαστή ή από εξειδικευμένο προσωπικό.

 **ΠΡΟΣΟΧΗ**



- Μην ενεργοποιείτε διακόπτες με βρεγμένα χέρια. Μπορεί να προκληθεί ηλεκτροπληξία.
- Μην χρησιμοποιείτε τη μονάδα για άλλους σκοπούς. Μην τοποθετείτε τρόφιμα, ζώα, φυτά κλπ πάνω στη μονάδα.
- Μην εκτείθετε ζώα ή φυτά στην ροή του αέρα. Μην καθαρίζετε την κλιματιστική μονάδα με νερό.
- Μην χρησιμοποιείτε εύφλεκτα καθαριστικά διότι μπορεί να προκληθεί πυρκαγιά ή παραμόρφωση της μονάδας.
- Μην τοποθετείτε κοντά στη μονάδα αντικείμενα που βγάζουν καπνό διότι μπορεί να επηρεάσουν τον εξερχόμενο αέρα.
- Μην πατάτε πάνω στη μονάδα και μην τοποθετείτε αντικείμενα πάνω σε αυτή.
- Μην χρησιμοποιείτε ασταθή ή σκουριασμένη βάση.
- Μην τοποθετείτε τη μονάδα σε μέρος που μπορεί να εκλυθεί εύφλεκτο αέριο. Μπορεί να προκληθεί έκρηξη.
- Μην λειτουργείτε τη μονάδα για πολλή ώρα αν οι πόρτες ή τα παράθυρα είναι ανοιχτά ή αν υπάρχει υψηλή σχετική υγρασία.
- Εάν το κλιματιστικό χρησιμοποιηθεί μαζί με άλλες θερμαντικές συσκευές θα πρέπει να ανανεώνεται συχνά ο αέρας αλλιώς υπάρχει κίνδυνος έλλειψης οξυγόνου.
- Να αποσυνδέετε πάντα το φιν από την πρίζα αν δεν χρησιμοποιήσετε τη μονάδα για αρκετό χρονικό διάστημα. Η συλλογή σκόνης μπορεί να προκαλέσει πυρκαγιά.
- Κατά τη διάρκεια καταιγίδας να απενεργοποιείτε τη μονάδα και να αποσυνδέετε το φιν από την πρίζα. Μπορεί να προκληθεί φθορά στα ηλεκτρικά μέρη.
- Ελέγξτε ότι ο αγωγός αποστράγγισης είναι συνδεδεμένος σωστά. Αν όχι, μπορεί να προκληθεί διαρροή νερού.
- Ελέγξτε ότι γίνεται ελεύθερη απορροή συμπυκνωμάτων.
- Η μονάδα θα πρέπει να είναι γειωμένη σύμφωνα με τους εθνικούς κανονισμούς.
- Για λόγους ασφαλείας συνιστούμε να τοποθετήσετε ένα ρελέ διαφυγής.
- Εάν το καλώδιο τροφοδοσίας είναι φθαρμένο, πρέπει να αντικατασταθεί από τον κατασκευαστή ή από εξειδικευμένο προσωπικό.

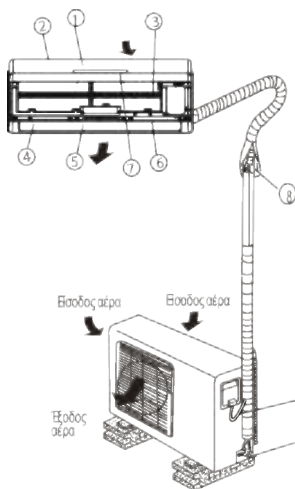

**Περιγραφή Εξαρτημάτων**

**Εσωτερική μονάδα**

1. Μπροστινό πάνελ
2. Είσοδος αέρα
3. Φίλτρο αέρα
4. Έξοδος αέρα
5. Οριζόντια περσίδα
6. Κάθετη περσίδα (μέσα)
7. Οθόνη

**Εξωτερική μονάδα**

8. Ψυκτικές σωληνώσεις
9. Καλώδιο σύνδεσης
10. Βαλβίδα

**ΣΗΜΕΙΩΣΗ:**

Όλες οι εικόνες που περιέχονται σε αυτό το εγχειρίδιο είναι μόνο για επεξηγηματικούς λόγους. Η μονάδα που έχετε προμηθευτεί μπορεί να διαφέρει στο μπροστινό πάνελ και στην οθόνη.

**Οθόνη Ενδείξεων**



- Ηλεκτρονική Ένδειξη:
- Ένδειξη ρύθμισης θερμοκρασίας όταν είναι το κλιματιστικό ενεργοποιημένο.
  - Ένδειξη θερμοκρασίας δωματίου σε λειτουργία FAN.
  - Ένδειξη κωδικών αυτοδιάγνωσης.
  - Ένδειξη 'ON', για τρία δευτερόλεπτα όταν οι λειτουργίες Timer ON, Fresh, Swing, Turbo or Silence είναι ενεργοποιημένες.
  - Ένδειξη 'OF' για τρία δευτερόλεπτα όταν η λειτουργία Timer ρυθμιστεί.
  - Ένδειξη 'OF', για τρία δευτερόλεπτα όταν διακοπούν οι λειτουργίες Fresh, Swing, Turbo ή Silence.
  - Ένδειξη 'dF' υπό συνθήκες αποπύκνωσης.
  - Ένδειξη 'cF' προστασίας από ψυχρό αέρα.
  - Ένδειξη 'SC' κατά τη λειτουργία αυτοκαθαρισμού (αν εφαρμόζεται).
  - Ένδειξη 'FP' κάτω από τους 8C κατά τη λειτουργία θέρμανσης (αν εφαρμόζεται)

**C (προαιρετικό)**

- Ανάλογα με τη λειτουργία, η ένδειξη "C" εμφανίζεται με διαφορετικό χρώμα:
- Υπό συνθήκες Ψύξης ή Αφύγρανσης, αναγράφεται με ψυχρό χρώμα.
  - Υπό συνθήκες Θέρμανσης, αναγράφεται με θερμό χρώμα.

**Οθόνη Ενδείξεων**



**ECO**

**Ένδειξη Εξοικονόμηση Ενέργειας**(προαιρετικό)  
Εμφανίζεται όταν ενεργοποιείται η λειτουργία εξοικονόμησης ενέργειας. (Δεν είναι διαθέσιμο όταν η μονάδα δεν έχει λειτουργία εξοικονόμησης ενέργειας).



**WIFI ένδειξη(προαιρετικό)**

Εμφανίζεται όταν ενεργοποιείται η λειτουργία WIFI. (Δεν είναι διαθέσιμο όταν η μονάδα δεν έχει αυτή τη λειτουργία)

**ΣΗΜΕΙΩΣΗ:**

Οδηγός χρήσης του τηλεχειριστηρίου, συμπεριλαμβάνεται σε αυτό το πακέτο.

**Θερμοκρασία λειτουργίας**

Κατάσταση λειτουργίας	Ψύξη	Θέρμανση	Αφύγρανση
Θερμοκρασία χώρου	17°C~32°C (62°F~90°F)	0°C~30°C (32°F~86°F)	10°C~32°C (50°F~90°F)
Θερμοκρασία εξωτερικού περιβάλλοντος	0°C~50°C (32°F~122°F)	-15°C~30°C ( 5°F~ 86°F)	0°C~ 50°C (32°F~122°F)
	(-15°C~ 50°C/5 °F~122 °F: Για τα μοντέλα με δυνατότητα ψύξης σε χαμηλές εξωτερικές θερμοκρασίες )		

**ΣΗΜΕΙΩΣΗ:**

1. Η βέλτιστη απόδοση επιτυγχάνεται σε αυτά τα εύρη θερμοκρασιών. Εάν το κλιματιστικό λειτουργεί εκτός των παραπάνω συνθηκών, θα ενεργοποιηθούν συγκεκριμένες προστασίες και η μονάδα δεν θα λειτουργεί σωστά.
  2. Εάν η μονάδα λειτουργεί για αρκετό χρονικό διάστημα σε ψύξη και η υγρασία είναι σε υψηλά επίπεδα (πάνω από 80%), μπορεί να εμφανιστούν συμπυκνώματα στην μονάδα. Ρυθμίστε την κάθετη περσίδα στη μέγιστη γωνία (κάθετα από το έδαφος) και ορίστε την μέγιστη ταχύτητα ανεμιστήρα.
- Πρόταση:** Για τις μονάδες με ηλεκτρική αντίσταση και όταν η εξωτερική θερμοκρασία είναι κάτω από τους 0 βαθμούς κελσίου, συνιστάται η μονάδα να παραμείνει συνδεδεμένη ώστε να εξασφαλιστεί η ομαλή της λειτουργία.

**Χειροκίνητη λειτουργία**

Οι μονάδες είναι εξοπλισμένες με ένα διακόπτη λειτουργίας έκτακτης ανάγκης. Είναι προσβάσιμη αν ανοίξετε το μπροστινό πάνελ. Αυτός ο διακόπτης χρησιμοποιείται για χειροκίνητη λειτουργία αν το ασύρματο τηλεχειριστήριο δεν λειτουργεί ή αν γίνονται εργασίες συντήρησης.

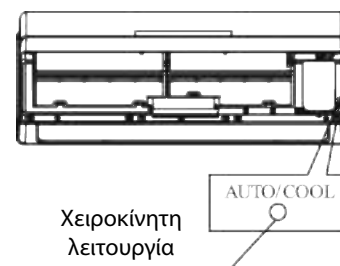

**ΣΗΜΕΙΩΣΗ:**

Για να χρησιμοποιήσετε το πλήκτρο χειροκίνητης λειτουργίας θα πρέπει η μονάδα να είναι απενεργοποιημένη. Εάν η μονάδα λειτουργεί πιάστε συνεχόμενα το πλήκτρο χειροκίνητης λειτουργίας έως ότου απενεργοποιηθεί η μονάδα.

1. Σηκώστε το μπροστινό πάνελ μέχρι να ακούσετε έναν ήχο "κλικ".
2. Αν πιέσετε το πλήκτρο χειροκίνητης λειτουργίας 1 φορά η μονάδα θα λειτουργήσει σε κατάσταση AUTO(Αυτόματη). Εάν το πιέσετε 2 φορές εντός 5 δευτερολέπτων, μονάδα θα λειτουργήσει σε κατάσταση COOL (Ψύξη).
3. Επαναφέρετε το πάνελ στην αρχική του θέση.

**ΠΡΟΣΟΧΗ:**

- Αυτός ο διακόπτης χρησιμοποιείται μόνο για έλεγχο λειτουργίας. Μην τον χρησιμοποιείτε.
- Για να επαναφέρετε τη λειτουργία του ασύρματου τηλεχειριστηρίου, χρησιμοποιήστε το απευθείας

**Ρύθμιση της κατεύθυνσης του αέρα**

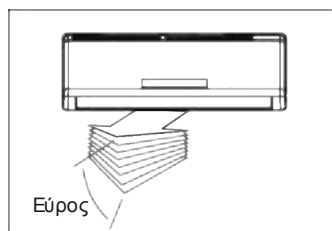

Ρυθμίστε σωστά την κατεύθυνση της ροής του αέρα αλλιώς το περιβάλλον θα είναι δυσάρεστο και δεν θα υπάρχει σωστή κατανομή της θερμοκρασίας στον χώρο. Ρυθμίστε την οριζόντια περσίδα από το ασύρματο τηλεχειριστήριο. Ρυθμίστε χειροκίνητα την κάθετη περσίδα.

**Ρύθμιση της κάθετης ροής αέρα (Πάνω-Κάτω)**

Αυτή η ρύθμιση πρέπει να γίνει ενώ η μονάδα λειτουργεί. Χρησιμοποιήστε το τηλεχειριστήριο ώστε να προσαρμόσετε τη κάθετη διάχυση του αέρα. Η οριζόντια περσίδα θα κινηθεί ελαφρώς σε κάθε πάτημα του κουμπιού ή αλλάζει συνεχόμενα θέση πάνω και κάτω αυτόματα. Ανατρέξτε στο εγχειρίδιο χρήσης του ασύρματου τηλεχειριστηρίου για λεπτομέρειες.

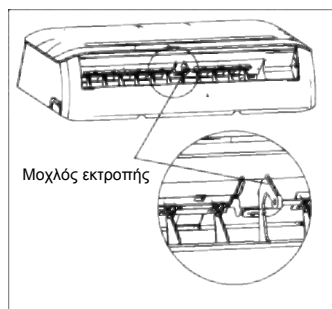

**Ρύθμιση της οριζόντιας ροής του αέρα (Αριστερά-Δεξιά)**

- Μετακινήστε τον μοχλό εκτροπής χειροκίνητα για να ρυθμίσετε την ροή του αέρα σύμφωνα με τις ανάγκες σας.

**ΣΗΜΑΝΤΙΚΟ:** Μην εισάγετε τα δάχτυλά σας στο εσωτερικό της μονάδας. Η υψηλή ταχύτητα του ανεμιστήρα μπορεί να προκαλέσει τραυματισμό.

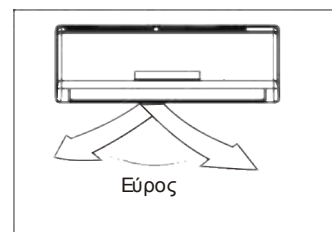

**⚠ ΠΡΟΣΟΧΗ**

- Όταν η μονάδα λειτουργεί σε ψύξη ή αφύγρανση, μην επιλέγεται για αρκετό χρονικό διάστημα η κατεύθυνση της ροής του αέρα να είναι προς τα κάτω. Μπορεί να δημιουργηθούν συμπυκνώματα στην οριζόντια περσίδα τα οποία θα στάζουν πάνω στο δάπεδο ή σε έπιπλα.
- Εάν απενεργοποιήσετε και ενεργοποιήσετε αμέσως τη μονάδα η οριζόντια περσίδα μπορεί να μην κινηθεί για 10 δευτερόλεπτα.
- Μην επιλέγετε μικρή γωνία ανοίγματος της περσίδας, διότι μπορεί να επηρεαστεί η ψυκτική ή θερμική απόδοση της μονάδας.
- Μην κινείτε χειροκίνητα την οριζόντια περσίδα διότι θα απορρυθμιστεί. Σε τέτοια περίπτωση σταματήστε τη λειτουργία, αποσυνδέστε το φις από την πρίζα για μερικά δευτερόλεπτα και έπειτα επανεκκινήστε το κλιματιστικό.
- Μην λειτουργείτε τη μονάδα με κλειστή την οριζόντια περσίδα. Αλλά αν αυτό συμβεί, παρακαλείσθε να σταματήσετε τη λειτουργία, να αποσυνδέσετε από το ρεύμα για μερικά δευτερόλεπτα και μετά να επανεκκινήσετε το κλιματιστικό.

**Πώς λειτουργεί το κλιματιστικό**

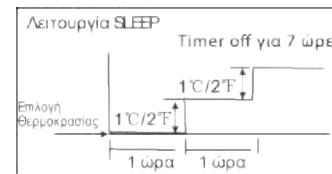

Ψύξη

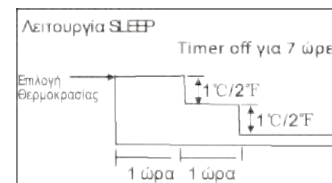

Θέρμανση

**Βασικές λειτουργίες:** AUTO/COOL/DRY/HEAT\*  
 (\*):Εξαρτάται το μοντέλο

**Λειτουργία AUTO (Αυτόματη)**

- Όταν επιλέξετε την λειτουργία AUTO, τότε η μονάδα θα επιλέγει αυτόματα την κατάσταση λειτουργίας (ψύξη θέρμανση ή ανεμιστήρας) ανάλογα με την επιλεγμένη θερμοκρασία και τη θερμοκρασία χώρου.
- Το κλιματιστικό θα ελέγχει τη θερμοκρασία του χώρου αυτόματα, σύμφωνα με την επιλεγμένη θερμοκρασία.
- Εάν η λειτουργία AUTO δεν είναι κατάλληλη για εσάς, μπορείτε να επιλέξετε την επιθυμητή.

**Λειτουργία FFP**

- Όταν επιλεγθεί, η ρύθμιση της θερμοκρασίας θα αυξηθεί (ψύξη) ή θα μειωθεί (θέρμανση) από 1°C-2°F ανά ώρα για τις πρώτες 2 ώρες. Από εκεί και έπειτα θα διατηρήσει τη νέα θερμοκρασία για 5 ώρες πριν κλείσει. Αυτή η λειτουργία εξοικονομεί ενέργεια και συμβάλλει στη βελτίωση της άνεσης αφού συγχρονίζεται με το μεταβολισμό του σώματος.

**Λειτουργία DRY (αφύγρανση)**

- Η θερμοκρασία ελέγχεται κατά την αφύγρανση από επαναλαμβανόμενο άνοιγμα και κλείσιμο της λειτουργίας ψύξης ή μόνο του ανεμιστήρα. Η ταχύτητα του ανεμιστήρα είναι ΧΑΜΗΛΗ.

**Λειτουργία HEATING (θέρμανση)**

Αυτό το κλιματιστικό λειτουργεί με βάση τις αρχές της αντλίας θερμότητας, απορροφώντας θερμότητα από τον εξωτερικό αέρα και μεταφέροντας αυτή τη θερμότητα στην εσωτερική μονάδα. Σαν αποτέλεσμα, η λειτουργική απόδοση μειώνεται όσο μειώνεται η εξωτερική θερμοκρασία. Αν αισθανθείτε ότι η απόδοση θέρμανσης είναι ανεπαρκής, σας συνιστούμε να χρησιμοποιήσετε αυτό το κλιματιστικό σε συνδυασμό με άλλες ηλεκτρικές συσκευές θέρμανσης.

**Βέλτιστη λειτουργία**

Για να επιτύχετε τη βέλτιστη λειτουργία, λάβετε υπόψη τα παρακάτω:

Ρυθμίστε την κατεύθυνση της ροής του αέρα έτσι ώστε να μην είναι απευθείας πάνω στα άτομα που βρίσκονται στον χώρο.

Ρυθμίστε τη θερμοκρασία ώστε να επιτύχετε το μέγιστο επίπεδο άνεσης. Μην ρυθμίζετε την θερμοκρασία σε υπερβολικά επίπεδα.

Κατά τη λειτουργία της ψύξης ή θέρμανσης κλείστε τις πόρτες και τα παράθυρα αλλιώς μπορεί να μειωθεί η απόδοσή.

Ελαχιστοποιήστε τη χρήση ενέργειας (run time) χρησιμοποιώντας τη λειτουργία TIMER.

Μην τοποθετείτε αντικείμενα κοντά στην είσοδο ή την έξοδο του αέρα, διότι μπορεί να μειωθεί η απόδοση της μονάδας ή να σταματήσει να λειτουργεί.

Επιθεωρήστε τα φίλτρα αέρα ανα τακτά χρονικά διαστήματα και καθαρίστε τα όταν αυτό χρειάζεται.

**Ειδικές λειτουργίες**

Έλεγχος διαρροής ψυκτικού υγρού (προαιρετικό)

Όταν παρατηρηθεί διαρροή ψυκτικού υγρού, η εσωτερική μονάδα θα εμφανίσει τον κωδικό "EC" ή τα LED θα αναβοσβήνουν (εξαρτάται το μοντέλο).

Αποθήκευση της γωνίας ανοίγματος της περσίδας (προαιρετικά):

Στο πλαίσιο μιας γωνίας ασφαλείας, η μονάδα θα αποθηκεύσει τη γωνία ανοίγματος της οριζόντιας περσίδας. Εάν την υπερβεί, θα αποθηκεύσει το όριο της γωνίας ασφαλείας και θα επιστρέψει στην τελευταία επιλογή θέσης που είχε επιλεγεί από τον χρήστη. Αυτό δεν θα συμβεί αν τα κουμπιά Turbo και Manual Control πατηθούν ή υπάρξει διακοπή ρεύματος. Συνιστάται η γωνία ανοίγματος να μην είναι πολύ μικρή, διότι μπορεί να σχηματιστούν συμπυκνώματα και να στάξουν από την οριζόντια περσίδα.

- Λειτουργία αυτόματου καθαρισμού (προαιρετικά)
- Αερομεταφερόμενα βακτήρια χρησιμοποιούν την υγρασία εσωτερικά του εναλλάκτη θερμότητας ώστε να αναπτυχθούν. Συχνή αφύγρανση του εναλλάκτη αποτρέπει την ανάπτυξή τους. Πατώντας το κουμπί SELF CLEAN το σύστημα αυτόματα ελέγχει τη διαδικασία αυτή. Αυτή η ενέργεια καθαρισμού μπορεί να γίνει όσο συχνά επιθυμείτε.
- Για ψυκτικές μονάδες, μόνο ο εσωτερικός ανεμιστήρας είναι ενεργοποιημένος σε χαμηλή ταχύτητα για 30 λεπτά και η μονάδα απενεργοποιείται αυτόματα.
- Για μονάδες ψύξης και θέρμανσης, η μονάδα λειτουργεί όπως στην ακόλουθη περίπτωση:  
Λειτουργία FAN σε ΧΑΜΗΛΗ ταχύτητα ανεμιστήρα--Λειτουργία ΘΕΡΜΑΝΣΗΣ με ΧΑΜΗΛΗ ταχύτητα ανεμιστήρα-- Λειτουργία FAN--Διακοπή Λειτουργίας--Απενεργοποίηση.  
ΣΗΜΕΙΩΣΗ
- Αυτή η λειτουργία ενεργοποιείται μόνο για κατάσταση ΨΥΞΗΣ ή ΑΦΥΓΡΑΝΣΗΣ.
- Πριν ενεργοποιήσετε το κλιματιστικό, συνιστάται να λειτουργήσετε το κλιματιστικό υπό συνθήκη ψύξης για περίπου 30 λεπτά.
- Πατώντας το κουμπί SELF CLEAN ή το κουμπί ON-OFF ξανά κατά τη διάρκεια του κύκλου καθαρισμού θα διακόψει τη λειτουργία και θα απενεργοποιηθεί η μονάδα.

Λειτουργία καθαρισμού του αέρα (σε ορισμένα μοντέλα)

Ένας από τους σκοπούς ενός κλιματιστικού είναι και ο καθαρισμός του αέρα. Αυτή η μονάδα είναι εξοπλισμένη με ιονιστή ή Plasma Dust Collector (ανάλογα το μοντέλο). Με τα ανιόντα που παράγονται από τον ιονιστή, η κυκλοφορία του αέρα από τη μονάδα προσφέρει στον χώρο ανανεωμένο, φυσικό και υγιεινό αέρα. Το Plasma Dust Collector παράγει μια ζώνη ιονισμού υψηλής τάσης. Η σκόνη, ο καπνός από τσιγάρα και τα σωματίδια αιχμαλωτίζονται από το ηλεκτροστατικό φίλτρο.

Λειτουργία για την αποφυγή δημιουργίας μούχλας (Προαιρετικά)

Κατά τις λειτουργίες COOL (ΨΥΞΗ), DRY (ΑΦΥΓΡΑΝΣΗ), AUTO (ΑΥΤΟΜΑΤΗ), όταν απενεργοποιήσετε τη μονάδα ο ανεμιστήρας θα συνεχίσει να λειτουργεί σε χαμηλή ταχύτητα για 7-10 λεπτά.

Αυτή η λειτουργία βοηθά στην απομάκρυνση της υγρασίας από το στοιχείο και έτσι αποφεύγεται η δημιουργία μούχλας. Κατά τη διάρκεια αυτής της λειτουργίας, μην επανεκκινήσετε την μονάδα αν προηγουμένως δεν έχει απενεργοποιηθεί

Λειτουργία Auto-restart (προαιρετικά)

Σε περίπτωση διακοπής ρεύματος, το κλιματιστικό σταματάει. Αλλά μόλις το η παροχή ρεύματος επανέλθει τότε θα ξεκινήσει αυτόματα να λειτουργεί βάση των προηγούμενων ρυθμίσεων που είχε.

Λειτουργία WIFI Control (προαιρετικά)

Για τα κλιματιστικά με λειτουργία WIFI Control, συνδέστε το WIFI module και συνδέστε το module με την οθόνη, έτσι ώστε να μπορεί να ελέγχεται είτε από το τηλεχειριστήριο είτε από το κινητό.

Λειτουργία Υπενθύμισης καθαρισμού Φίλτρων (προαιρετικό)

Λειτουργία Υπενθύμισης καθαρισμού Φίλτρων:  
Έπειτα από 240 ώρες λειτουργίας, η εσωτερική οθόνη θα εμφανίσει μια ένδειξη "CL" λειτουργίας που προειδοποιεί για καθαρισμό του φίλτρου αέρα για περισσότερο αποδοτική λειτουργία. Μετά από 15 δευτερόλεπτα, το σύστημα θα επιστρέψει στην αρχική οθόνη. Όταν η ένδειξη "CL" εμφανιστεί και αναβοσβήσει, παρακαλείσθε να πατήσετε το LED κουμπί στο τηλεχειριστήριο για 4 φορές ή να πατήσετε το κουμπί ελέγχου Manual 3 ή περισσότερες φορές ώστε να μηδενίσετε τις καταγεγραμμένες ώρες, αλλιώς η "CL" ένδειξη θα εμφανιστεί και θα αναβοσβήσει πάλι για ακόμα 15 δευτερόλεπτα την επόμενη φορά που θα εκκινήσετε τη μονάδα.

Λειτουργία αντικατάστασης φίλτρου αέρα

Μετά από 2880 ώρες λειτουργίας, η εσωτερική οθόνη θα εμφανίσει τη λειτουργία "nF" να αναβοσβήσει η οποία προειδοποιεί για αντικατάσταση του φίλτρου αέρα για περισσότερο αποδοτική λειτουργία. Μετά από 15 δευτερόλεπτα, το σύστημα επανέρχεται στις προηγούμενες ρυθμίσεις. Όταν η "nF" ένδειξη εμφανιστεί και αναβοσβήσει, παρακαλείσθε να πατήσετε το LED κουμπί στο τηλεχειριστήριο για 4 φορές ή να πατήσετε το κουμπί ελέγχου Manual για 3 ή και περισσότερες φορές ώστε να μηδενίσετε τις καταγεγραμμένες ώρες λειτουργίας, αλλιώς η ένδειξη "nF" θα εμφανιστεί και θα αναβοσβήσει ξανά για 15 δευτερόλεπτα την επόμενη φορά που θα λειτουργήσει η μονάδα.

Λειτουργία Σίγασης(προαιρετικό)

Αν πατήσετε το LED κουμπί στο τηλεχειριστήριο απενεργοποιεί την εσωτερική οθόνη και απενεργοποιεί επίσης τον προειδοποιητικό ήχο του κλιματιστικού, δημιουργώντας έτσι ένα άνετο και ήσυχο περιβάλλον.

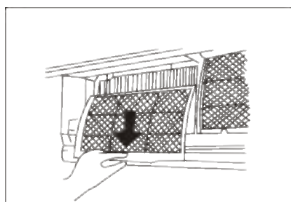
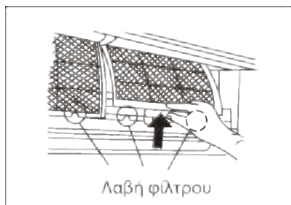
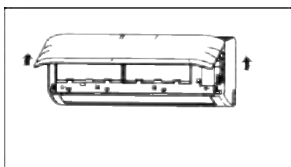
**Καθαρισμός και Συντήρηση**

Φίλτρο καθαρισμού αέρα

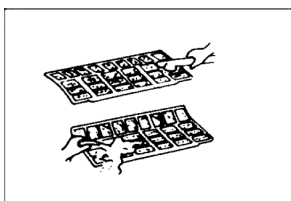
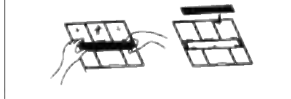

**ΠΡΟΣΟΧΗ:** Τεχνικές εργασίες πρέπει να γίνονται μόνο σύμφωνα με τις οδηγίες του κατασκευαστή. Η συντήρηση και επισκευή πρέπει να πραγματοποιείται υπό την επίβλεψη τεχνικού πιστοποιημένου στα εύφλεκτα ψυκτικά υγρά. Για περισσότερες πληροφορίες παρακαλούμε συμβουλευτείτε το "Εγχειρίδιο εγκατάστασης".

**Πριν τη συντήρηση**

- Απενεργοποιήστε την μονάδα πριν τον καθαρισμό και καθαρίστε τη με ένα μαλακό στεγνό πανί. Μην χρησιμοποιείτε λευκαντικά ή σπλιβωτικά

**ΣΗΜΕΙΩΣΗ :** Πριν τον καθαρισμό, θα πρέπει να έχετε αποσυνδέσει την μονάδα από την παροχή ρεύματος.

**⚠ ΠΡΟΣΟΧΗ**

- Μην χρησιμοποιείτε χημικά επεξεργασμένο ξεσκονόπανο για τον καθαρισμό.
  - Μην χρησιμοποιείτε βενζίνη, διαλυτικά, σπλιβωτικά ή παρόμοια διαλύματα για τον καθαρισμό. Μπορεί να προκαλέσουν παραμόρφωση ή ράγισμα στις πλαστικές
  - επιφάνειες της μονάδας.
- Μην χρησιμοποιείτε για τον καθαρισμό του μπροστινού πάνελ νερό πάνω από 40 °C. Μπορεί να προκληθεί παραμόρφωση ή αποχρωματισμός.

**Καθαρισμός της μονάδας**

Χρησιμοποιήστε ένα μαλακό, στεγνό πανί. Αν η μονάδα είναι πολύ βρώμικη χρησιμοποιήστε ένα βρεγμένο πανί

**Καθαρισμός του φίλτρου αέρα και του αντιμικροβιακού φίλτρου.**

Ένα φραγμένο φίλτρο μειώνει την απόδοση της μονάδας. Παρακαλούμε να καθαρίζετε τα φίλτρα κάθε 15 ημέρες.

1. Σηκώστε το μπροστινό πάνελ μέχρι να ακούσετε έναν ήχο "κλικ". Για ορισμένα μοντέλα χρησιμοποιήστε τις αναρτήσεις για να στερεώσετε το πάνελ.
2. Τραβήξτε το φίλτρο από τη λαβή προς τα έξω και κάτω ανασηκώνοντας το ελαφρώς προς τα πάνω.
- 3) Αφαιρέστε το μικρό φίλτρο αέρα από το μεγάλο. Καθαρίστε το με ηλεκτρική σκούπα και φροντίστε να το αντικαθιστάτε περιοδικά.
- 4) Καθαρίστε το μεγάλο φίλτρο αέρα με σαπουνώδες νερό. Ξεβγάλτε με καθαρό νερό. Κουνήστε το για να αποβάλλετε το νερό και αφήστε το σε δροσερό σημείο να αφυγρανθεί. Φορντίστε να το αντικαθιστάτε περιοδικά.

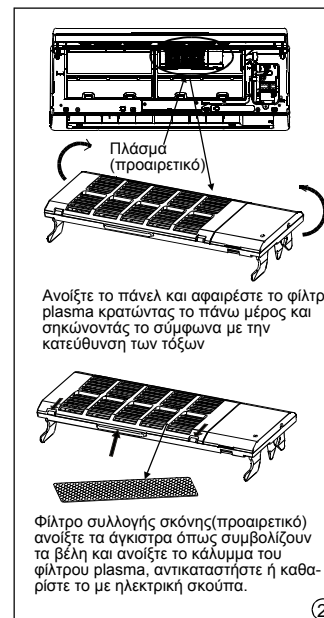

②

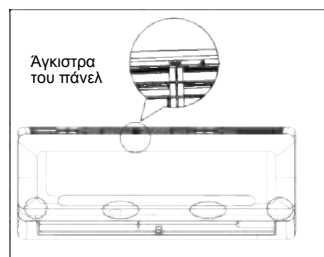
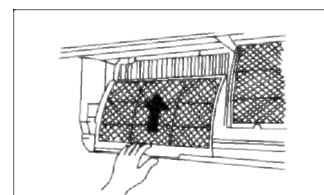

Για τα μοντέλα που υιοθετούν Plasma, μην αγγίζετε το φίλτρο πλάσμα για δέκα λεπτά μετά την παύση λειτουργίας της μονάδας. Καθαρίστε το φίλτρο plasma σύμφωνα με την περιγραφή της αριστερής εικόνας.

5. Ξαναεφαρμόστε το μικρό φίλτρο αέρα πάνω στο μεγάλο.
6. Επανατοποθετήστε στη μονάδα σε αντίθετη φορά όπως περιγράφεται στο σημείο 2 παραπάνω.
7. Κλείστε το μπροστινό πάνελ. Βεβαιώστε ότι εφαρμόζεται τέλεια και το πάνελ είναι τελείως κλειστό.

**Προετοιμασία για το τέλος της περιόδου χρήσης**

Όταν δεν θα χρησιμοποιήσετε τη μονάδα για αρκετό χρονικό διάστημα, να κάνετε τις παρακάτω ενφύγιες:

- 1) Καθαρίστε την εσωτερική μονάδα και τα φίλτρα
- 2) Λειτουργήστε τον ανεμιστήρα για περίπου μισή ώρα ώστε να απομακρυνθεί υγρασία από το εσωτερικό της μονάδας.
- 3) Απενεργοποιήστε τη λειτουργία της μονάδας και αποσυνδέστε την παροχή ρεύματος.
- 4) Αφαιρέστε τις μπαταρίες από το ασύρματο τηλεχειριστήριο.

Η εξωτερική μονάδα χρειάζεται περιοδική συντήρηση και καθαρισμό. Μην κάνετε αυτές τις εργασίες μόνοι σας.

Επικοινωνήστε με τον προμηθευτή σας.

**Έλεγχοι πριν την έναρξη περιόδου χρήσης**

- Ελέγξτε ότι τα καλώδια δεν είναι φθαρμένα και πως δεν είναι αποσυνδεδεμένα.
- Καθαρίστε την εσωτερική μονάδα και τα φίλτρα.
- Ελέγξτε διαρροή νερού ή λαδιών.
- Βεβαιωθείτε πως δεν παρεμποδίζεται η έσοδος και η έξοδος του αέρα, εφόσον η μονάδα δεν έχει λειτουργήσει για αρκετό χρονικό διάστημα.

**⚠ Προσοχή**

- Όταν αφαιρείτε τα φίλτρα μην ακουμπάτε τα μεταλλικά μέρη της μονάδας, υπάρχει κίνδυνος τραυματισμού. Μην καθαρίζετε το εσωτερικό της μονάδας με νερό.
- Μπορεί να καταστραφεί η μόνωση και να προκληθεί ηλεκτροπληξία.
- Κατά τον καθαρισμό της μονάδας βεβαιωθείτε πως η μονάδα δεν είναι συνδεδεμένη με την παροχή ρεύματος και ο διακόπτης είναι σε θέση off.
- Μην πλένετε τα φίλτρα με νερό πάνω από 40°C. Στεγνώστε το σε σκιερό μέρος και μην το εκτείθετε απευθείας στην ηλιακή ακτινοβολία. Μπορεί να συρρικνωθούν

**Συμβουλές για περιπτώσεις σφάλματος**

Οι ακόλουθες περιπτώσεις μπορεί να συμβούν κατά τη διάρκεια ομαλής λειτουργίας και μπορεί να μην υποδεικνύουν κάποια δυσλειτουργία.

Πρόβλημα	Αιτία
Καθυστέρηση λειτουργίας μετά την επανεκκίνηση	Για να μην πέσει η ασφάλεια, ο συμπιεστής δεν θα λειτουργήσει όταν είναι σε λειτουργία ο κύκλος προστασίας για περίπου 3 λεπτά έπειτα από ξαφνική ON/OFF λειτουργία της παροχής ρεύματος.
Η ταχύτητα του ανεμιστήρα αλλάζει από πολύ αργή σε φυσιολογική	Συμβαίνει αυτόματα κατά τη λειτουργία θέρμανσης: -αποτρέπει την αποβολή κρύου αέρα όταν η λειτουργία θέρμανσης ξεκινήσει, -εμφανίζει αυτόματη λειτουργία αποπάγωσης -εμφανίζει λειτουργία θέρμανσης σε χαμηλή θερμοκρασία
Η λειτουργία θέρμανσης σταματάει ξαφνικά και η ανάβει η λυχνία αποπάγωσης	Σε λειτουργία Θέρμανσης, η εσωτερική μονάδα προσωρινά σταματάει για 10 λεπτά ώστε να ξεκινήσει αυτόματα την αποπάγωση.
Βγαίνει νεφέλωμα από την εσωτερική μονάδα	Σε κασάσταση Ψύξης, μπορεί να πορκληθεί λόγω της υγραποίησης νεφέλωμα με τη ξαφνική λειτουργία ψύξης. Νεφέλωμα μπορεί να εμφανιστεί λόγω της υγρασίας που δημιουργείται κατά τη διαδικασία αποπάγωσης όταν επανεκκινείται το κλιματιστικό σε κατάσταση Θέρμανσης μετά την αποπάγωση.
Το κλιματιστικό βγάζει χαμηλής έντασης ήχους	Ήχος σφουρίγματος-- κατά τη διάρκεια λειτουργίας ή αμέσως μετά το κλείσιμο του κλιματιστικού, μπορεί ευθύνεται η ροή του ψυκτικού υγρού. Ήχος τριξίματος-- φυσιολογική έκταση και συστολή των πλαστικών και μεταλλικών μερών που προκαλείται από θερμοκρασιακή αλλαγή κατά τη λειτουργία. Έντονος ήχος-- όταν η περσίδα αλλάζει θέση.
Σκόνη αποβάλλεται από τη μονάδα	Μπορεί να συμβεί όταν το κλιματιστικό χρησιμοποιείται για πρώτη φορά ή δεν έχει χρησιμοποιηθεί για πολύ καιρό.
Αποβάλλεται περίεργη μυρωδιά	Διάφορες μυρωδιές προκαλούνται από τα εσωτερικά υφάσματα, έπιπλα ή καπνό τσιγάρου, απορροφώνται από το κλιματιστικό και αποβάλλονται έπειτα στο χώρο. Αν δεν είναι αυτή η περίπτωση, καλέστε εξειδικευμένο κέντρο σέρβις.
Αλλαγές στον ανεμιστήρα μόνο κατά τη λειτουργία ψύξης ή θέρμανσης	Η θερμοκρασία δωματίου φθάνει τη θερμοκρασία που έχει ρυθμιστεί από το τηλεχειριστήριο. Αν δεν είναι αυτή η περίπτωση, καλέστε εξειδικευμένο κέντρο σέρβις.
Η λειτουργία είναι ακανόνιστη, απρόβλεπτη ή δεν ανταποκρίνεται	Παρεμβολές από τη κεραία του κινητού και από ενισχυτές σήματος μπορεί να προκαλέσουν δυσλειτουργία της μονάδας. Αποσυνδέστε από το ρεύμα και επανασυνδέστε. Πατήστε το κουμπί ON/OFF στο τηλεχειριστήριο για να επανεκκινήσετε τη λειτουργία.

**ΣΗΜΕΙΩΣΗ:** Αν δεν λυθεί το πρόβλημα, παρακαλώ επικοινωνήστε με τον τοπικό εμπορικό δίκτυο ή το κοντινότερο κέντρο σέρβις. Βεβαιωθείτε ότι τους ενημερώσατε επαρκώς για τις δυσλειτουργίες της μονάδας καθώς και αριθμό του μοντέλου.

**Συμβουλές για περιπτώσεις σφάλματος**

Πριν καλέσετε ή ζητήσετε να εξυπηρετηθείτε, λύστε το πρόβλημα ακολουθώντας τα παρακάτω:

Πρόβλημα	Διάγνωση
Η μονάδα δεν λειτουργεί	-- Υπάρχει κάποιο πρόβλημα με τη παροχή ρεύματος;
	-- Υπάρχει κάποια καμμένη ασφάλεια, έχει πέσει κάποια ασφάλεια;
	-- Λειτουργεί ο χρονοδιακόπτης;
	-- Μήπως χρειάζεται αντικατάσταση των μπαταριών του τηλεχειριστήριου;
Μειωμένη απόδοση ψύξης ή θέρμανσης	-- Έχουν τοποθετηθεί σωστά οι μπαταρίες στο τηλεχειριστήριο;
	-- Είναι βρώμικα τα φίλτρα αέρα;
	-- Εμποδίζεται η εξαγωγή&εισαγωγή αέρα στην εξωτερική&εσωτερική μονάδα;
	-- Είναι σωστά ρυθμισμένα η θερμοκρασία και η κατάσταση λειτουργίας;
	-- Είχαν αφαιρεθεί ανοιχτά οι πόρτες και τα παράθυρα?
	-- Είναι η ταχύτητα του ανεμιστήρα ρυθμισμένη στο μέγιστο και οι περσίδες να επιτρέπουν τη μέγιστη διάχυση?
Λυχνίες διαφόρων ενδείξεων συνεχίζουν να αναβοσβήνουν	-- Υπάρχει απευθείας αντανάκλαση του ήλιου στο δωμάτιο που ψύχεται από τη μονάδα;
	-- Υπάρχουν άλλες ηλεκτρικές συσκευές θέρμανσης ή λειτουργία υπολογιστών, ή μεγάλος αριθμός ατόμων στο δωμάτιο κατά τη διάρκεια ψύξης;
	-- Έχει ενεργοποιηθεί η λειτουργία "SILENCE"? Υπό λειτουργία "SILENCE", υποχρεωτικά θα πέσει η ένταση του ήχου και θα πέσει και η απόδοση του κλιματιστικού.
Κωδικός Σφαλμάτων εμφανίζονται στην εσωτερική μονάδα, όπως: E0, E1, E2...P1, P2, P3... ή F1, F2, F3	-- Η μονάδα μπορεί να σταματήσει να λειτουργεί ή να συνεχίσει τη λειτουργία σε ασφαλές συνθήκες (εξαρτάται τη κατάσταση λειτουργίας). Περιμένετε για περίπου 10 λεπτά και το σφάλμα μπορεί να λυθεί αυτόματα. Αν όχι, αποσυνδέστε από το ρεύμα και επανασυνδέστε. Αν το πρόβλημα συνεχίσει να υπάρχει, αποσυνδέστε από το ρεύμα και επικοινωνήστε με το κοντινότερο κέντρο σέρβις.

Αν το πρόβλημα συνεχίσει να υπάρχει παρόλο που κάνετε τις παραπάνω διαγνώσεις και ελέγχους, σταματήστε αμέσως τη λειτουργία του κλιματιστικού και επικοινωνήστε με εξειδικευμένο κέντρο σέρβις. Βεβαιωθείτε ότι τους ενημερώσατε επαρκώς για τις δυσλειτουργίες της μονάδας καθώς και τον αριθμό του μοντέλου.

**⚠️ ΠΡΟΣΟΧΗ**

**Στη περίπτωση ΟΠΟΙΟΥΔΗΠΟΤΕ από τα ακόλουθα, απενεργοποιήστε αμέσως τη μονάδα!**

- Καλώδιο παροχής ρεύματος είναι κατεστραμμένο ή ασυνήθιστα ζεστό.
- Μυρίζουν καμμένα ηλεκτρόδια.
- Δυνατοί ή ασυνήθιστοι ήχοι ακούγονται.
- Έχει πέσει η ασφάλεια ή υπάρχει βραχυκύκλωμα.
- Νερό ή άλλα στοιχεία έχουν πέσει μέσα ή έξω της μονάδας.

**⚠️ ΜΗΝ ΕΠΙΧΕΙΡΗΣΕΤΕ ΜΟΝΟΙ ΣΑΣ ΕΠΙΣΚΕΥΕΣ ΣΤΗ ΣΥΣΚΕΥΗ! ΕΠΙΚΟΙΝΩΝΗΣΤΕ ΜΕ ΕΞΟΥΣΙΟΔΟΤΗΜΕΝΟ ΣΕΡΒΙΣ!**



Ενεργοποιήστε την εγγύηση σας...

σε **5**  
απλά  
βήματα!



Σκανάρετε εδώ  
για τα έντυπα  
των εγγυήσεων

- 1** Συνδεθείτε στο site της  Inventor στον ακόλουθο σύνδεσμο <http://www.inventoraircondition.gr/egiisi-inventor/>
- 2** Επιλέξτε τον τύπο του προϊόντος (κλιματιστικό ή συσκευή) για το οποίο θα ενεργοποιηθεί η εγγύηση
- 3** Επιλέξτε την εγγύηση που αντιστοιχεί στο προϊόν που έχετε στην κατοχή σας
- 4** Συμπληρώστε τα απαιτούμενα στοιχεία (κατόχου, εμπόρου και συσκευής) και πατήστε αποστολή
- 5** Θα λάβετε επιβεβαιωτικό μήνυμα στο e-mail σας για την ενεργοποίηση της εγγύησης

Για την υποβολή  
ηλεκτρονικών εγγυήσεων  
ηλεκτρολογήστε  
την παρακάτω διεύθυνση

**<http://www.inventoraircondition.gr/egiisi-inventor/>**

## CITIȚI ÎNAINTE DE UTILIZARE

Atunci când folosiți acest aparat de aer condiționat în țările europene, trebuie urmărită următoarea informație:

- Acest aparat poate fi folosit de copii cu vârsta de peste 8 ani și de către persoanele cu capacități fizice și mentale reduse sau cu lipsă de experiență sau cunoștințe dacă sunt supravegheați sau li se acordă instruire cu privire la folosirea aparatului în siguranță și dacă înțeleg pericolele pe care le implică. Copiii nu trebuie să se joace cu aparatul. Menținerea uzuală și curățarea nu se vor face de către copii fără supraveghere.

**ELIMINARE:** Nu aruncați acest produs ca și gunoi menajer. Este necesară colectarea unui astfel de deșeu separat pentru acordarea de tratament special.

Este interzisă aruncarea acestui aparat în gunoiul menajer al gospodăriei. Pentru eliminare există mai multe posibilități:

- A) Municipality a stabilit sisteme de colectare a deșeurilor, în care gunoiul de natură electronică poate fi eliminat fără taxarea utilizatorului.
- B) La cumpărarea unui nou produs, vânzătorul va lua la schimb vechiul produs fără costuri suplimentare.
- C) Producătorul va lua înapoi vechiul aparat fără taxarea utilizatorului.
- D) Deoarece produsele vechi conțin resurse valoroase, acestea pot fi vândute la comercianții de fier vechi. Eliminarea produsului în păduri sau pe diverse terenuri pune în pericol sănătatea dvs. când substanțe periculoase se scurg în pânza freatică și reușesc să pătrundă în lanțul alimentar.



## CUPRINS

### **PRECAUȚII PENTRU SIGURANȚĂ**



AVERTIZARE .....	3
ATENȚIE .....	4
<b>DENUMIREA COMPONENTELOR</b> .....	5
Unitatea interioară .....	5
Unitatea exterioară .....	5
Ecranul de afișaj .....	5
<b>INSTRUCȚIUNI DE UTILIZARE</b> .....	6
Temperatura de funcționare: .....	6
Funcționarea manuală .....	6
Controlul direcției fluxului de aer .....	7
Cum funcționează aparatul de aer condiționat .....	8
Funcții speciale .....	9
<b>ÎNGRIJIRE ȘI ÎNTREȚINERE</b> .....	11
Înainte de întreținere .....	11
Curățarea unității .....	11
Curățarea filtrului de aer și a filtrul de împăstrăare a aerului .....	11
Pregătirea pentru perioade extinse de nefuncționare .....	12
Verificarea înainte de utilizarea în sezon .....	12
<b>SFATURI PENTRU DEPANARE</b> .....	13
Sfaturi pentru depanare .....	13
Ghid de depanare .....	14





Atenție:  
risc de incendiu / materiale inflamabile

## PRECAUȚII PENTRU SIGURANȚĂ

Pentru a preveni vătămarea utilizatorului sau a altor oameni sau distrugerea materială, trebuie urmate instrucțiunile de mai jos. Folosirea incorectă datorată ignorării instrucțiunilor poate duce la vătămarea de persoane sau pagube materiale. Gradul de seriozitate este indicat de următoarele indicatoare.

	AVERTIZARE	Acest simbol indică posibilitatea vătămării sau a decesului.
	ATENȚIE	Acest simbol indică posibilitatea vătămării de persoane sau cauzarea de daune materiale.

■ Descrierea simbolurilor folosite în acest manual sunt cele de mai jos:

	<b>Strict interzis.</b>
	<b>Asigurați-vă că urmați întotdeauna instrucțiunile.</b>

### AVERTIZARE

- Nu prelungiți cablul și nu utilizați mai multe prize. O conexiune electrică slabă, o izolare necorespunzătoare sau o tensiune mai mare decât cea permisă poate provoca un incendiu.
- Nu vă expuneți corpul direct la fluxul de aer rece pentru o perioadă îndelungată.
- Nu introduceți degetele, bețe sau alte obiecte în orificiile de admisie și evacuare a aerului.
- Nu încercați niciodată să reparați, mutați sau să modificați echipamentul de aer condiționat. Întotdeauna contactați partenerul dvs. de service, dacă este nevoie.
- Nu scoateți ștecherul din priză trăgând de cablu. Apucați ferm ștecherul și trageți-l afară din priză, altfel există riscul de deteriorare a cablului.
- Nu folosiți aparatul de aer condiționat într-o cameră cu umezeală ridicată, cum ar fi o baie sau spălătorie.
- Îndepărtați toată murdăria de pe cablul de alimentare și conectați-l cu fermitate. Prizele murdare pot provoca un incendiu sau un șoc electric.
- În caz de anomalii în funcționare, cum ar fi mirosul de ars, opriți imediat aparatul și scoateți-l din priză. Contactați furnizorul de service.
- Întotdeauna opriți aparatul și scoateți ștecherul din priză înainte de a începe să-l curățați.
- Utilizați cablul de alimentare specificat.
- Contactați instalatorul autorizat pentru instalarea acestui aparat
- Contactați un tehnician de service autorizat pentru reparația sau întreținerea acestui aparat
- Acest aparat nu este destinat utilizării de către persoane (inclusiv copii) cu capacități fizice reduse, senzoriale sau mentale, sau lipsite de experiență și cunoștințe, cu excepția cazului în care acestea au fost supravegheate și instruite cu privire la utilizarea aparatului de către o persoană responsabilă pentru siguranța lor.
- Copiii trebuie supravegheați pentru a ne asigura că nu se joacă cu aparatul de aer condiționat.

## PRECAUȚII PENTRU SIGURANȚĂ

### ATENȚIE

- Nu acționați niciodată orice întrerupătoare cu mâinile ude. Acest lucru poate provoca un șoc electric.
- Nu utilizați niciodată aparatul în alt scop decât cel pentru care a fost fabricat. Nu puneți niciodată alimente, instrumente de precizie, plante, animale, vopsea etc. pe echipamentul de aer condiționat
- Nu expuneți plantele sau animalele direct fluxului de aer
- Nu curățați niciodată aparatul de aer condiționat cu apă.
- Nu utilizați niciodată agenți de curățare, combustibili, deoarece ar putea provoca un incendiu sau deformare.
- Nu așezați obiecte care ard aproape de aparat, dacă acestea ar putea fi afectate în mod direct de aerul emis de aparat
- Nu călcați pe unitatea externă și nu așezați nimic pe ea
- Nu folosiți niciodată o bază instabilă sau ruginită. Nu instalați aparatul de aer condiționat în locuri în care pot fi emise gaze sau lângă combustibil. Gazele emise se pot acumula și provoca o explozie.
- Nu lăsați niciodată aparatul de aer condiționat să funcționeze pentru prea mult timp, cu ușile și ferestrele deschise, sau în cazul în care umiditatea este foarte mare.
- În cazul în care aparatul de aer condiționat este utilizat în combinație cu alte încălzitoare, aerul ar trebui împropătat periodic, în caz contrar există riscul de lipsă de oxigen
- Decuplați întotdeauna cablul de alimentare de la priză în cazul în care unitatea nu va fi folosită pentru o perioadă lungă de timp. Acumularea de praf poate provoca incendii.
- Întotdeauna opriți aparatul de aer condiționat și scoateți ștecherul din priză în timpul unei furtuni. Piesele electrice pot fi deteriorate.
- Verificați dacă furtunul de scurgere este conectat corect. Dacă nu, apa va curge din echipament.
- Verificați dacă apa acumulată se poate elimina fără probleme. Aceasta apă poate provoca daune în cazul în care tava de condensare nu este instalată în mod corespunzător
- Aparatul de aer condiționat trebuie să fie împământat în conformitate cu codurile locale.
- Din motive de siguranță electrică, vă recomandăm să instalați o siguranță pentru împământare.
- În cazul în care cablul de alimentare este deteriorat, acesta trebuie înlocuit de către producător, agentul de service sau persoane calificate, în scopul de a evita un pericol.

## DENUMIREA COMPONENTELOR

### Unitate interioară

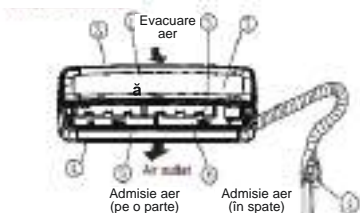

### Unitate exterioară

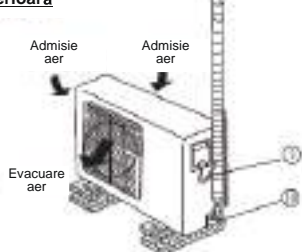

### Ecran afișaj



## ECO

### Panou cu economisire de energie (opțional)

Este afișat atunci când este activată funcția de economisire energie. (Nu este disponibilă atunci când unitatea nu este prevăzută cu funcția de economisire energie)



### Afișaj control prin WIFI

Este afișat atunci când este activată funcția de control prin WIFI. (Nu este disponibilă atunci când unitatea nu este prevăzută cu această funcție).

### NOTĂ:

Un ghid cu privire la utilizarea telecomenzii cu infraroșu este inclus în acest pachet.

### Denumirea componentelor

#### Unitatea Interioară

- 1 Panou frontal
- 2 Admisie aer
- 3 Filtru de aer
- 4 Refulare aer
- 5 Flaps-uri orizontale de ghidare a aerului
- 6 Flaps-uri de ghidare a aerului (interioare)
- 7 Ecran afișaj
- 8 Telecomandă

#### Unitatea Exterioară

- 9 Țeava de conectare, furtun scurgere
- 10 Admisie aer (lateral și spate)
- 11 Unitate refulare aer

### NOTĂ:

Toate imaginile din acest manual sunt doar pentru scopuri de prezentare. Forma actuală a unității interioare pe care ați achiziționat-o poate fi ușor diferită la panoul frontal și ecranul de afișaj. Forma actuală are prioritate.

### Ecranul de afișaj



Afișaj digital:

- Afișează setările de temperatură atunci când aparatul de aer condiționat este în funcțiune.
- Afișează temperatura camerei în modul ventilație.
- Afișează codurile de diagnosticare.
- Afișează 'ON' pentru trei secunde atunci când sunt activate: temporizatorul, funcțiile de împăspătare, oscilație, Turbo sau funcția silențioasă.
- Afișează 'OF' pentru trei secunde atunci când este oprit temporizatorul.
- Afișează 'OF' pentru trei secunde atunci când funcțiile de împăspătare, oscilație, Turbo sau funcția silențioasă sunt anulate.
- Afișează 'dF' în timpul operațiunii de degivrare.
- Afișează 'cF' atunci când este activată funcția anti-răcire în cadrul modului de încălzire.
- Afișează 'SC' în timpul operațiunii de auto-curățare
- Afișează 'FP' în cadrul funcționării încălzirii la sub 8°C (dacă este cazul)

### °C (opțional)

Conform modului de funcționare, indicatorul '°C' afișează o culoare diferită.

- În cadrul modului răcire sau dehumidificare, este afișat într-o culoare rece
- În cadrul modului răcire sau dehumidificare, este afișat într-o culoare caldă

## INSTRUCȚIUNI DE UTILIZARE

### Temperatura de funcționare:

Temperatură	Modul		Funcționare în modulul dehumidificare
	Funcționare în modulul răcire	Funcționare în modulul încălzire	
Temperatură interioară	17°C~32°C (62°F~90°F)	0°C~30°C (32°F~86°F)	10°C~32°C (50°F~90°F)
Temperatură exterioară	0°C~50°C (32°F~122°F)	-15°C~30°C (5°F~86°F)	0°C~50°C (32°F~122°F)
	-15°C~50°C/ 5°F~122°F (Pentru modele cu sisteme de răcire cu temperaturi joase)		

### NOTĂ:

1. Performanța optimă va fi atinsă în aceste temperaturi de funcționare. În cazul în care aparatul de aer condiționat este utilizat în afara condițiilor de mai sus, anumite caracteristici de protecție și siguranță s-ar putea activa și cauza funcționarea anormală a aparatului.
2. În cazul în care aparatul de aer condiționat funcționează pentru o lungă perioadă de timp în modul de răcire, iar umiditatea este ridicată (peste 80%), apă din condens se poate scurge din unitate. Vă rugăm setați flaps-urile în poziție verticală la unghiul maxim (vertical pe podea), și ventilatorul pe viteză mare.  
**Sugestie:** Pentru aparatul la care se montează un încălzitor electric auxiliar, atunci când temperatura ambientală exterioară este sub 0 °C (32 °F), vă recomandăm să vă păstrați aparatul conectat, în scopul de a garanta o funcționare fără probleme.

### Funcționarea manuală

Unitățile sunt echipate cu un comutator pentru a opera în modul de funcționare de urgență. Acesta poate fi accesat prin deschiderea panoului frontal. Acest comutator este utilizat pentru operarea manuală, în cazul în care telecomanda nu funcționează sau este necesară o reparare a echipamentului.

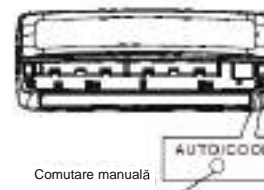

### NOTĂ:

Unitatea trebuie să fie oprită înainte de a utiliza butonul de control manual. În cazul în care unitatea este în funcțiune, continuați să apăsați butonul de control manual, până când aparatul se oprește

- 1) Deschideți și ridicați panoul frontal până la un unghi în care rămâne fix cu un sunet de clic.
- 2) O singură apăsare a comutatorului de control manual va conduce la funcționarea AUTO forțată. Dacă apăsați butonul de două ori în cinci secunde, aparatul va funcționa în modul RĂCIRE (COOL) forțată
- 3) Închideți ferm panoul frontal în poziția sa inițială

### ATENȚIE:

- ! Acest comutator este utilizat numai în scop de testare. Este de preferat să nu îl utilizați.
- ! Pentru a restabili funcționarea din telecomandă, folosiți telecomanda direct.

# INSTRUCȚIUNI DE UTILIZARE

## Controlul direcției fluxului de aer

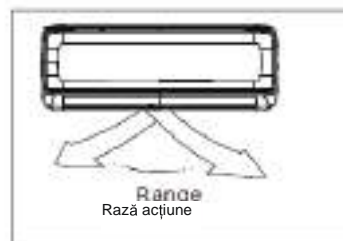
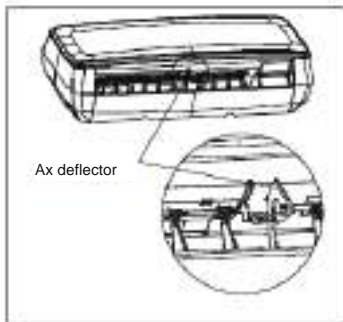
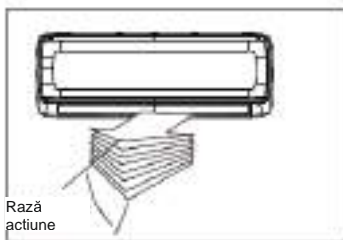

- Reglați direcția fluxului de aer în mod corespunzător în caz contrar s-ar putea cauza un disconfort sau se determină apariția temperaturilor inegale în camere.
- Reglați flaps-urile orizontale utilizând telecomanda.
- Reglați manual flaps-urile verticale.

### Ajustarea fluxului de aer vertical

Efectuați această operațiune în timp ce aparatul este în funcțiune. Utilizați telecomanda pentru a regla direcția fluxului de aer. Flaps-ul orizontal poate fi mutat ușor la fiecare apăsare, sau să oscileze în sus și în jos în mod automat. Vă rugăm să consultați „MANUALUL DE FUNCȚIONARE AL TELECOMENZII” pentru detalii.

### Ajustarea fluxului de aer orizontal (stânga-dreapta)

- Mutați manual axul deflector, pentru a regla fluxul de aer în direcția pe care o preferați

**IMPORTANT:** Nu inserați degetele în panoul de pe partea suflantă și de admisie aer. Ventilatorul de mare viteză din interior poate cauza vătămare.

### NOTĂ:

Cele mai bune condiții de lucru (consumul de energie poate fi afectat dacă nu este setat în aceste condiții):

- Cel mai bun unghi al flaps-urilor este unghiul automat al modului de răcire
- Cea mai bună metodă de setare a unghiului flaps-urilor este de funcționare timp de 5 minute și apoi utilizare a telecomenzii pentru setarea flaps-urilor la unghiul automat al modului de răcire.



### ATENȚIE:

- Nu folosiți aparatul de aer condiționat pentru perioade lungi de timp, cu direcția fluxului de aer stabilit în jos în modul de răcire sau dezumidificare. În caz contrar, se poate forma condens pe suprafața flaps-urilor orizontale ce duce ca apa rezultată din condens să cadă pe podea sau pe mobilier.
- După o repornire, flaps-ul orizontal poate rămâne nemișcat pentru aproximativ 10 secunde.
- Unghiul de deschidere al flaps-urilor orizontale nu trebuie să fie prea mic, deoarece funcția de RĂCIRE sau ÎNCĂLZIRE poate fi afectată din cauza că zona de eliberare a fluxului de aer este prea limitată

- Nu mișcați manual flaps-urile orizontale deoarece nu se vor mai sincroniza. Vă rugăm opriți funcționarea, scoateți din priză și reporniți aparatul de aer condiționat.

# INSTRUCȚIUNI DE UTILIZARE

## Cum funcționează aparatul de aer condiționat

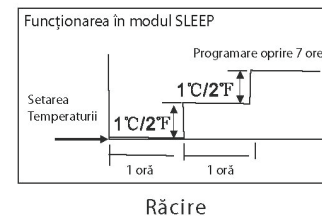

Răcire

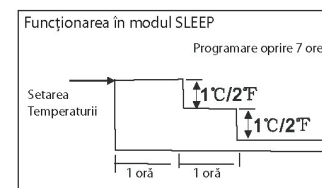

**Moduri operaționale de bază:** AUTO/COOL/DRY/HEAT\* (\*) în funcție de model

### Funcționarea automată (AUTO)

! Când setați aparatul de aer condiționat în modul AUTO, se va selecta în mod automat funcția de răcire, încălzire (numai pentru modelele cu funcție de răcire / încălzire), sau doar ventilare în funcție de temperatura setată și temperatura camerei.

! Aparatul de aer condiționat va controla temperatura camerei, în mod automat la punctul de temperatură setat.

! Dacă vă simțiți incomfortabil în modul AUTO, puteți seta temperatura dorită.

### Funcționarea în modul în așteptare (SLEEP)

Atunci când setați pe modulul SLEEP va crește temperatura cu 1°C/2°F, în mod automat (în modul răcire) sau scadea (în modul încălzire) pe oră pentru primele 2 ore. Apoi o păstrează în mod constant pentru următoarele 5 ore, după care se va opri.

Acest mod economisește energie și va aduce confort pe timp de noapte prin sincronizare cu metabolismul corpului.

### Funcția de dezumidificare (DRY)

! Temperatura este reglată prin dezumidificare prin repetarea pornirii și opririi operațiunii de răcire sau a ventilatorului. Viteza de ventilație este mică (LOW).

### Funcționarea în modul încălzire (HEATING)

Acest aparat de aer condiționat funcționează pe principiul pompei de căldură absorbând aer din exterior și transferându-l încălzit în interior. Ca și rezultat, performanța de funcționare este redusă pe măsură ce temperatura exterioară scade.

Dacă credeți că performanța încălzirii este insuficientă, vă recomandăm utilizarea aerului condiționat împreună cu alte tipuri de aparate de încălzire.

### Funcționarea optimă

Pentru a obține performanțe optime, vă rugăm să rețineți următoarele aspecte:

- Ajustați direcția fluxului de aer în mod corect, astfel încât să nu fie îndreptat către oameni
- Setați temperatura astfel încât să atingeți cel mai înalt nivel de confort. Niveluri excesive de temperatură irosesc energia.
- Închideți ușile și ferestrele pentru îmbunătățirea performanței echipamentului.
- Utilizați funcția TIMER pentru a limita consumul de energie (timpul de funcționare).
- Nu puneți nici un obiect în apropierea fantei de admisie sau de evacuare a aerului, deoarece eficiența aparatului de aer condiționat poate fi redusă și echipamentul se poate opri.
- Verificați periodic filtrele de aer și curățați-le la nevoie.

## INSTRUCȚIUNI DE UTILIZARE

### Funcții speciale

#### Detecția scurgerii agentului frigorific (opțională)

Când este detectată scurgerea agentului frigorific, unitatea interioară va afișa codul 'EC' sau ledurile vor pâlpâi (în funcție de model).

#### Funcția de memorare a unghiului flaps-urilor (opțională):

În cadrul unghiului de siguranță, flaps-urile orizontale au unghiul memorat și se vor întoarce la poziția selectată ultima oară de către utilizator. Dacă depășește, aceasta va memora limitele unghiului de siguranță. Acest lucru nu se va întâmpla atunci când butoanele Turbo sau cel de control manual sunt apăsatate sau după o întrerupere a alimentării electrice. Astfel, vă sugerăm insistent ca unghiul de deschidere al flaps-urilor orizontale să nu fie setat prea mic, pentru a evita situația în care se adună apă din condens și picură din flaps-urile orizontale.

#### Funcția de auto - curățare (opțională)

- Bacteriile aeriene se folosesc de umiditatea din schimbătorul de căldură al unității interioare pentru a se înmulți. Uscarea regulată a schimbătorului previne această înmulțire. Prin simpla apăsare a butonului de auto curățare, sistemul va gestiona automat procesul. Această acțiune de curățare poate fi realizată oricât de des doriți.
- Pentru modelele cu răcire, numai ventilatorul interior este activ la viteze mici pentru 30 de minute iar unitatea se oprește automat.
- Pentru modelele cu răcire și încălzire, unitatea va funcționa în următoarea ordine: Ventilator la viteză mică – Încălzire la viteză mică a ventilatorului – ventilator – oprire funcționare – oprire.

#### Notă:

- Această funcție este activată doar în modul de RĂCIRE sau DEZUMIDIFICARE.
- Înainte de activarea aparatului de aer condiționat, este recomandat să porniți aerul condiționat în modul de răcire pentru aproximativ 30 de minute.
- Apăsarea butonului de ON / OFF al funcției de AUTO CURĂȚARE în timpul ciclului de curățare va anula operațiunea și va opri unitatea.

#### Funcția de îmbunătățire aer (opțională)

Îmbunătățirea calității aerului din încăperea este unul dintre scopurile unui aparat de aer condiționat. Acest aer condiționat este echipat cu funcție de ionizare sau colectori de praf cu plasma (în funcție de model). Prin anioni generați de către funcția de ionizare, circulația aerului din aparatul de aer condiționat aduce în cameră aer îmbunătățit, natural și sănătos. Colectorul de praf cu plasmă generează o ionizare cu voltaj ridicat într-o anumită zonă, prin care aerul este transformat în plasmă. În interiorul aparatului mare parte din praf, fum și particule de polen sunt captate de către filtrul electrostatic.

#### Funcția anti-mucegai (opțională)

Când se oprește unitatea în modul de răcire, dezumidificare, automat (răcire), aparatul de aer condiționat va continua să funcționeze pentru aproximativ 10 minute (în funcție de model) cu o suflare ușoară. Acest lucru va ajuta la uscarea apei din condens din interiorul unității de evaporare, și previne creșterea de mucegai. În cadrul funcționării anti mucegai, nu reporniți aparatul de aer condiționat până ce unitatea nu este complet oprită.

#### Funcția de auto pornire (opțională)

În cazul unei întreruperi de curent de genul unei pene de curent, aparatul de aer condiționat se oprește imediat. Însă acesta pornește automat și funcționează în setarea anterioară atunci când alimentarea electrică este restabilă.

## INSTRUCȚIUNI DE UTILIZARE

#### Funcția de control prin WIFI (opțională)

Pentru unitățile cu funcție de control prin WIFI, conectați modulul WIFI și modulul de comunicare cu afișaj, astfel încât unitatea să fie controlată fie prin telecomandă fie prin telefonul mobil.

#### Funcția de amintire pentru filtrul de aer (opțională)

##### Funcția de amintire pentru curățarea filtrului:

După 240 de ore de funcționare, ecranul unității interioare va afișa intermitent 'CL'. , Această funcție este o amintire pentru curățarea filtrului de aer pentru o funcționare mai eficientă. După 15 secunde, sistemul va reveni la afișajul anterior. Atunci când indicatorul 'CL' apare intermitent, vă rugăm apăsați butonul LED de pe telecomandă de patru ori sau apăsați butonul de control manual de trei ori sau de mai multe ori pentru a șterge orele înregistrate, altfel indicatorul 'CL' va fi afișat din nou pentru încă 15 secunde la următoarea dată de pornire a unității.

##### Funcția de amintire a înlocuirii filtrului:

După 2880 de ore de funcționare, ecranul unității interioare va afișa intermitent mesajul 'nF', această funcție amintește înlocuirea filtrului de aer pentru o funcționare mai eficientă. După 15 secunde sistemul va reveni la afișajul anterior. Atunci când indicatorul 'nF' apare intermitent, vă rugăm apăsați butonul LED de pe telecomandă de patru ori sau apăsați butonul de control manual de trei ori sau de mai multe ori pentru a șterge orele înregistrate, altfel indicatorul 'nF' va fi afișat din nou pentru încă 15 secunde la următoarea dată de pornire a unității.

#### Funcționarea silențioasă (opțional)

Apăsați butonul LED de pe telecomandă pentru a opri ecranul de afișaj al unității interioare și pentru a opri sunetul bătăit al aparatului de aer condiționat, ce creează un mediu confortabil și silențios.

## ÎNGRIJIRE ȘI ÎNTREȚINERE

### Îngrijire și întreținere

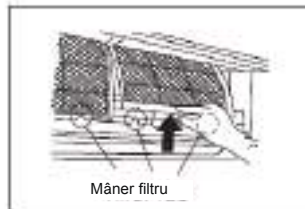
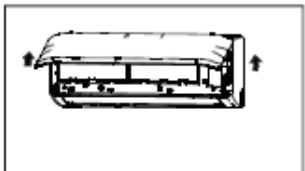

Mâner filtru

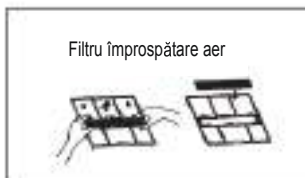
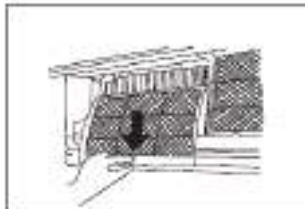

Filtru împrosătare aer



**ATENȚIE:** Menținerea se efectuează numai la recomandarea producătorului echipamentului. Întreținerea și repararea care necesită asistența unui personal calificat se efectuează sub supravegherea unei persoane competente în utilizarea de agenți frigorifici inflamabili. Pentru mai multe detalii, vă rugăm să consultați informațiile privind depanarea din MANUALUL DE INSTALARE.

### Înainte de întreținere

• Opiți aparatul înainte de curățare. Pentru a curăța, ștergeți cu o cârpă moale, uscată. A nu se folosi înălțitor sau substanțe abrazive.

**NOTĂ: Sursa de alimentare trebuie să fie deconectată înainte de a curăța unitatea interioară!**

### ⚠ ATENȚIE

- Nu utilizați o cârpă tratată chimic sau aspirator de praf pentru a curăța aparatul.
- Nu folosiți benzină, diluant, praf de lustruire, sau solvenți similari pentru curățare. Acestea pot duce la spargerea sau deformarea suprafeței de plastic.
- Niciodată nu folosiți apă la o temperatură mai mare de 40 °C/104 °F pentru a curăța panoul frontal, ar putea provoca deformarea sau decolorarea acestuia.

### Curățarea aparatului

Ștergeți aparatul numai cu o cârpă moale și uscată. În cazul în care aparatul este foarte murdar, ștergeți-l cu o cârpă înmuiată în apă caldă.

### Curățarea filtrului de aer și a filtrul de împrosătare a aerului

Un filtru de aer înfundat reduce eficiența de răcire a acestui echipament. Vă rugăm să curățați filtrul o dată la 2 săptămâni.

1. Ridicați panoul de la unitatea interioară cu atenție ridicând de la ambele capete în același timp.
2. Apucați mânerul filtrului de aer și ridicați-l ușor să-l îndepărtați din suportul de filtru, apoi trageți-l în jos. Acum scoateți filtrul trăgând ușor în jos.
3. Scoateți filtrul mic de împrosătare aer din filtrul mare. Curățați-l cu un aspirator și înlocuiți-l din când în când.
4. Curățați filtrul mare cu apă și săpun. Clătiți cu apă curată. Scuturați excesul de apă și uscați-l într-un loc răcoros, înlocuiți-l din când în când.

## ÎNGRIJIRE ȘI ÎNTREȚINERE

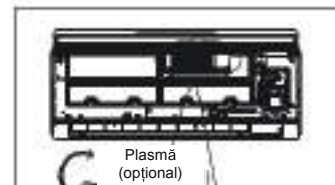

Plasmă (opțional)

Deschideți panoul pentru a îndepărta filtrul cu plasmă, ținând partea de sus a filtrului cu plasmă și ridicându-l în sus conform săgeților.



Filtru de colectare praf (opțional)

Mișcați în deschidere clemele după cum indică săgețile, și deschideți capacul Plasmei, curățați cu aspiratorul sau înlocuiți filtrul.

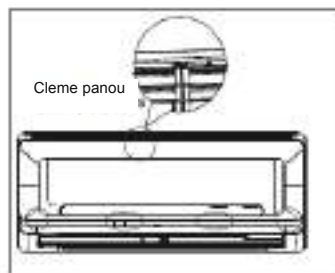
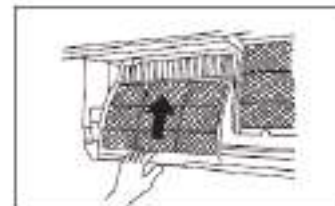

Cleme panou

Pentru modelele cu plasmă, nu atingeți filtrul colector plasmă de praf timp de 10 minute după deschiderea panoului frontal. Curățați filtrul de plasmă conform desenelor din stânga.

5. Instalați filtrul de împrosătare a aerului înapoi în filtrul mare de aer.
6. Re-introduceți în unitate în ordinea inversă de la punctul 2 de mai sus.
7. Închideți panoul frontal. Asigurați-vă că clemele sunt la locul lor și panoul este închis complet.

### Pregătirea pentru perioade extinse de nefuncționare

Dacă aveți de gând să nu folosiți aparatul pentru o lungă perioadă de timp, efectuați următoarele:

- (1) Curățați unitatea interioară și filtrele
- (2) Lăsați să funcționeze ventilatorul aproximativ o jumătate de zi pentru a usca interiorul unității.
- (3) Opiți aparatul de aer condiționat și deconectați-l de la priză.
- (4) Scoateți bateriile din telecomandă. Unitatea exterioară necesită întreținere și curățare periodică. Nu încercați să o realizați singuri. Contactați furnizorul de service.

### Verificarea înainte de utilizarea în sezon

- Verificați dacă cablajul nu este rupt sau deconectat.
- Curățați unitatea interioară și filtrele.
- Verificați scurgerile de apă sau ulei.
- Verificați dacă fanta de refulare a aerului sau dacă orificiul de intrare este blocat după ce instalația de aer condiționat nu a fost folosit pentru o perioadă lungă de timp.

### ⚠ ATENȚIE

- Nu atingeți părțile metalice ale unității când scoateți filtrul. Leziunile pot apărea la manipularea marginilor metalice ascuțite.
- Nu folosiți apă pentru a curăța în interiorul instalației de aer condiționat. Expunerea la apă poate distruge izolația, ceea ce duce la posibile șocuri electrice. Când curățați unitatea, în primul rând asigurați-vă că echipamentul este deconectat de la rețeaua electrică.
- Nu spălați filtrul de aer cu apă caldă la o temperatură mai mare de 40°C/104°F. Scuturați-l ferm de umiditate și uscați-l la umbră. Nu-l expuneți direct la soare, se poate micșora.

## SFATURI PENTRU DEPANARE

### Sfaturi pentru depanare

Următoarele evenimente pot apărea în timpul funcționării normale, și pot să nu indice defecțiune

Simptom	Cauză
<b>Funcționarea este întârziată după pornire</b>	Pentru a preveni arderea siguranței, compresorul nu va funcționa atâta timp cât circuitul de protecție este pornit, pentru aproximativ 3 minute după o funcționare OFF – ON bruscă a alimentării cu electricitate.
<b>Viteza ventilatorului se schimbă – se oprește, merge încet și apoi normal</b>	Se întâmplă automat în modul de încălzire: – Previne aerul rece să fie suflat în încăperea atunci când pornește operațiunea de încălzire, – Realizează operațiunea automată de degivrare, – Efectuează operațiunea de încălzire la temperatură joasă
<b>Funcționarea încălzirii se oprește brusc și pâlpâie lumina de degivrare</b>	În modul de încălzire, unitatea interioară se oprește temporar pentru maxim 10 minute pentru a realiza operațiunea de degivrare.
<b>lese ceață din unitatea interioară</b>	În modul de răcire, se emite o ceață prin condensarea formată în timpul procesului brusc de răcire.
	Ceața poate fi generată datorită umezelii din procesul de degivrare atunci când aparatul de aer condiționat pornește în modul de funcționare încălzire după degivrare.
<b>Sunete de intensitate scăzută sunt emise de aparatul de aer condiționat</b>	Un sunet foșnăit – în timpul funcționării sau imediat după oprirea aparatului de aer condiționat, poate fi auzit sunetul curgerii agentului frigorific.
	Sunet de chițăit – expansiunea și contracția normală a componentelor de plastic și metal cauzată de schimbarea temperaturii în timpul funcționării.
	Aer care circulă – atunci când flaps-urile își resetează poziția.
<b>lese praf din unitate</b>	Poate apărea atunci când aparatul de aer condiționat este utilizat prima oară sau nu a fost utilizat pentru o perioadă lungă de timp.
<b>Un miros special este emis</b>	Diverse mirosuri sunt emise din materialele interioare, mirosurile mobilei sau de țigări absorbite de aerul condiționat ce pot fi emise. Dacă nu este cazul, chemați furnizorul adecvat.
<b>Se trece pe ventilator doar în modul de răcire sau încălzire</b>	Temperatura camerei atinge setarea de temperatură a telecomenzii. Dacă nu este cazul chemați furnizorul adecvat.
<b>Funcționarea este haotică, neprevizibilă sau nu răspunde</b>	Interferențe din turnurile de telefonie mobilă și amplificatoare de distanță pot cauza funcționarea improprie a unității.
	Deconectați de la alimentare și reconectați.
	Apăsăți butonul ON / OFF al telecomenzii pentru a reporni funcționarea.

**Notă:** dacă problema nu este rezolvată, vă rugăm contactați un furnizor local sau cel mai apropiat centru de service pentru clienți. Asigurați-vă că explicați defecțiunea în detaliu, precum și numărul modelului unității.

## SFATURI PENTRU DEPANARE

### Ghid de depanare

Înainte să chemați sau să solicitați serviciile de mentenanță, depanați o problemă prin realizarea următoarelor verificări:

Simptom	Diagnostic
<b>Unitatea nu funcționează</b>	Există o cădere de curent?
	Înterupătorul a fost oprit, un comutator a fost declanșat sau o siguranță s-a ars?
	Temporizatorul funcționează?
	Bateriile utilizate în telecomandă sunt uzate?
	Bateriile utilizate în telecomandă sunt încărcate adecvat?
<b>Performanță de răcire sau încălzire slabă</b>	Filtrele de aer sunt murdare?
	Fluxul de aer nu este restricționat în interiorul și exteriorul unităților interioare și exterioare?
	Setările de temperatură și modul de funcționare sunt corecte?
	Aveți uși sau ferestre deschise?
	Viteza ventilatorului este setată pe mare și flaps-urile permit un flux maxim?
	Lumina directă și puternică a soarelui intră în încăperea în timpul operațiunii de răcire?
<b>Lumina indicatorului continue să pâlpâie</b>	Există alte aparate de încălzire sau calculatoare, sau prea mulți oameni în încăperea în timpul răcirii?
	<b>Apar coduri de eroare la unitatea interioară, cum ar fi: E0, E1, E2,...P1, P2, P3,...SAU F1, F2, F3...</b>
<b>Apar coduri de eroare la unitatea interioară, cum ar fi: E0, E1, E2,...P1, P2, P3,...SAU F1, F2, F3...</b>	Funcția silențioasă este activată? În cadrul funcționării silențioase, reducerea zgomotului are prioritate și performanța aparatului de aer condiționat poate scădea. Unitatea poate opri funcționarea sau poate continua să funcționeze în condiții de siguranță (în funcție de model). Dacă așteptați aproximativ 10 minute, codul de eroare poate dispărea automat, dacă nu, deconectați de la alimentare cu energie și apoi conectați din nou aparatul. Dacă problema există încă, deconectați de la alimentare și contactați cel mai apropiat centru de service pentru clienți.

Dacă problema persista chiar dacă ați realizat aceste verificări sau diagnostice, opriți imediat funcționarea și contactați centrul de service autorizat. Asigurați-vă că explicați defecțiunea în detaliu, precum și numărul modelului unității.



### ATENȚIE

În cazul oricăror dintre următoarele situații, opriți imediat unitatea!

- Cablul de alimentare este avariât sau anormal de fierbinte.
- Sunt mirosuri de ars
- Sunt auzite sunete puternice sau anormale
- Se arde o siguranță sau un întrerupător se declanșează în mod frecvent.
- Apă sau alte obiecte cad în sau din unitate.



### NU ÎNCERCAȚI SĂ CORECTAȚI ACESTE ELEMENTE! CONTACTAȚI UN FURNIZOR DE SERVICE AUTORIZAT!